

# JVC



The default setting of On-Screen Display language for this recorder is ENGLISH.

## VIDEO CASSETTE RECORDER

# HR-J459EE HR-J259EE



The recorder illustrations appearing in this instruction manual are of the HR-J459EE.

**SHOWVIEW** **VHS**  
PAL

## INSTRUCTIONS

## ENGLISH

### CONTENTS

<b>SAFETY FIRST</b>	<b>2</b>
Safety Precautions .....	2
<b>INSTALLING YOUR NEW RECORDER 3</b>	
Basic Connections .....	3
<b>INITIAL SETTINGS 4</b>	
Video Channel Set .....	4
Auto Set Up .....	6
Select Language .....	8
Clock Set .....	9
On-Screen Displays .....	10
<b>INFORMATION ON COLOUR SYSTEM 11</b>	
Colour System Set .....	11
<b>PLAYBACK 12</b>	
Basic Playback .....	12
Playback Features .....	13
<b>RECORDING 16</b>	
Basic Recording .....	16
Recording Features .....	17
B.E.S.T. Picture System .....	18
<b>TIMER RECORDING 20</b>	
SHOWVIEW Setup .....	20
SHOWVIEW Timer Programming ...	22
Express Timer Programming ....	24
Automatic Satellite Programme Recording .....	28
<b>SPECIAL FEATURES 29</b>	
TV Multi-Brand Remote Control .....	29
<b>EDITING 30</b>	
Edit To Another Video Recorder .....	30
Edit From A Camcorder Or Another Video Recorder .....	31
<b>TUNER SET 32</b>	
<b>QUESTIONS AND ANSWERS 39</b>	
<b>TROUBLESHOOTING 40</b>	
<b>INDEX 43</b>	
<b>SPECIFICATIONS 46</b>	

# Safety Precautions

The rating plate and the safety caution are on the rear of the unit.

**WARNING: DANGEROUS VOLTAGE INSIDE**

**WARNING: TO PREVENT FIRE OR SHOCK HAZARD, DO NOT EXPOSE THIS UNIT TO RAIN OR MOISTURE.**

## CAUTION

- When you are not using the recorder for a long period of time, it is recommended that you disconnect the power cord from the mains outlet.
- Dangerous voltage inside. Refer internal servicing to qualified service personnel. To prevent electric shock or fire hazard, remove the power cord from the mains outlet prior to connecting or disconnecting any signal lead or aerial.

## ATTENTION

1. This recorder can also receive SECAM colour television signals for recording and playback.
2. Recordings made of SECAM television signals produce monochrome pictures if played back on another video recorder of SECAM standard, or do not produce normal colour pictures if played back on another video recorder of PAL standard.
3. SECAM prerecorded cassettes or recordings made with a SECAM video recorder produce monochrome pictures when played back with this recorder.

## POWER SYSTEM

This set operates on voltage of AC110 – 240 V $\sim$  (Rating), AC90 – 260 V $\sim$  (Operating), 50/60 Hz with automatic switching.

## IMPORTANT

- Please read the various precautions on this page before installing or operating the recorder.
- It should be noted that it may be unlawful to re-record pre-recorded tapes, records, or discs without the consent of the owner of copyright in the sound or video recording, broadcast or cable programme and in any literary, dramatic, musical, or artistic work embodied therein.

The STANDBY/ON  $\phi$ /I button does not completely shut off mains power from the unit, but switches operating current on and off. "  $\phi$  " shows electrical power standby and " I " shows ON.

### HR-J459EE:

Video tapes recorded with this video recorder in the LP (Long Play) mode cannot be played back on a single-speed video recorder.

### HR-J259EE:

LP and EP mode recording and playback are not possible with this video recorder.

**Failure to heed the following precautions may result in damage to the recorder, remote control or video cassette.**

### 1. **DO NOT** place the recorder . . .

- ... in an environment prone to extreme temperatures or humidity.
- ... in direct sunlight.
- ... in a dusty environment.
- ... in an environment where strong magnetic fields are generated.
- ... on a surface that is unstable or subject to vibration.

### 2. **DO NOT** block the recorder's ventilation openings.

### 3. **DO NOT** place heavy objects on the recorder or remote control.

### 4. **DO NOT** place anything which might spill on top of the recorder or remote control.

### 5. **AVOID** violent shocks to the recorder during transport.

## MOISTURE CONDENSATION

Moisture in the air will condense on the recorder when you move it from a cold place to a warm place, or under extremely humid conditions—just as water droplets form in the surface of a glass filled with cold liquid. Moisture condensation on the head drum will cause damage to the tape. In conditions where condensation may occur, keep the recorder turned on for a few hours to let the moisture dry.

## ABOUT HEAD CLEANING

Accumulation of dirt and other particles on the video heads may cause the playback picture to become blurred or interrupted. Be sure to contact your nearest JVC dealer if such troubles occur.

### Auto Head Cleaner

A built-in head cleaner automatically cleans the video heads and head drum whenever a tape is loaded or unloaded to reduce head clogging.

VHS  
PAL

HQ

SHOWVIEW

- Only cassettes marked "VHS" can be used with this videorecorder.
- HQ VHS is compatible with existing VHS equipment.
- SHOWVIEW is a registered trademark of Gemstar Development Corporation. The SHOWVIEW system is manufactured under licence from Gemstar Development Corporation.

# Basic Connections

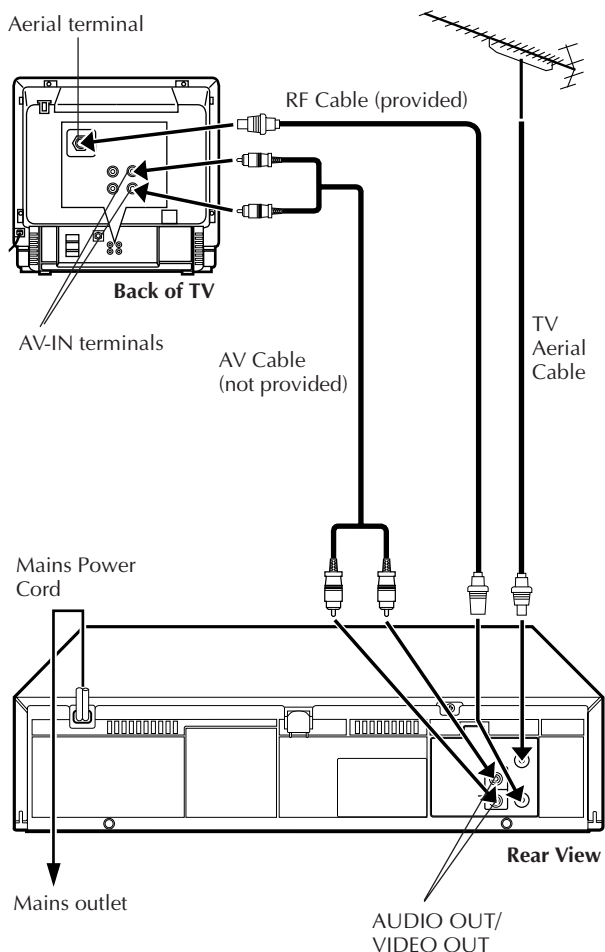

It's essential that your video recorder be properly connected. Follow these steps carefully. THESE STEPS MUST BE COMPLETED BEFORE ANY VIDEO OPERATION CAN BE PERFORMED.

1

## CHECK CONTENTS

Make sure the package contains all of the accessories listed in "Specifications" (pg. 46).

2

## SITUATE RECORDER

Place the recorder on a stable, horizontal surface.

3

## CONNECT RECORDER TO TV

The connection method you use depends on the type of TV you have.

### RF CONNECTION

- To Connect To A TV With NO AV Input Terminals . . .
  - a- Disconnect the TV aerial cable from the TV.
  - b- Connect the TV aerial cable to the ANT. IN jack on the rear panel of the recorder.
  - c- Connect the provided RF cable between the RF OUT jack on the rear panel of the recorder and the TV's aerial terminal.

### AV CONNECTION

- To Connect To A TV With AV Input Terminals . . .
  - a- Connect the aerial, recorder and TV as per "RF CONNECTION".
  - b- Connect an optional AV cable between the AUDIO OUT and VIDEO OUT connectors on the rear panel of the recorder and the TV's AV-IN terminals .

4

## CONNECT RECORDER TO MAINS

Plug the end of the mains power cord into a mains outlet.

## ATTENTION

If you have finished all the necessary connections, go to "Video Channel Set" on page 4, then perform Auto Set Up on page 6; do NOT press the  button on the recorder/remote control to turn on the recorder's power before you start Auto Set Up.

# Video Channel Set

Video Channel (RF Output Channel) is the channel on which your TV receives picture and sound signals from the video recorder through the RF cable.

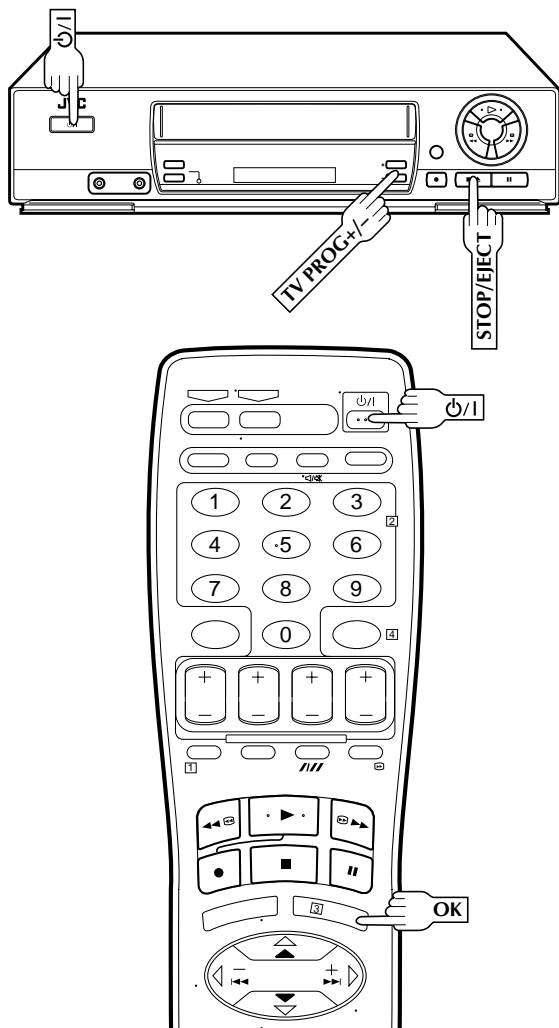

## TEST SIGNAL

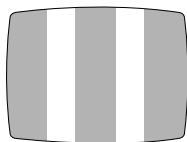

The channel on which the screen to the left appear clearly in step 3 is your Video Channel.

To view picture signals from the video recorder, set your TV to the Video Channel.

If you have connected the video recorder to your TV via the provided RF cable only (RF connection) – Go to "With RF Connection" below.

If you have connected the video recorder to your TV via both the provided RF cable and an AV cable (AV connection) – Go to "With AV Connection" on next page.

## With RF Connection

### IMPORTANT:

Before performing the following steps, make sure the recorder's power is off and there is no cassette inserted in the recorder.

## ACCESS VIDEO CHANNEL SET MODE

1 Hold down **STOP/EJECT** on the recorder until the display panel shows the following.

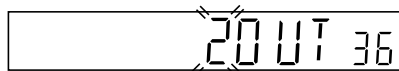

## SELECT TV SYSTEM

2 Press **TV PROG +** or **-** to set appropriate TV system that matches the system of TV being used (refer to the table below).



1 : B/G 2 : D/K

Major Countries	TV System
Austria, Denmark, Finland, Holland, Italy, Norway, Spain, Switzerland, Sweden, Germany, Egypt	B/G
China, Mongolia, Rumania, Bulgaria, Czech Rep., Slovakia, Hungary, Poland, Russia	D/K

## SET VIDEO CHANNEL

3

Set your TV to UHF channel 36.

- If the two vertical white bars appear clearly on the screen as shown in the illustration (☞ "TEST SIGNAL" on page 4), press **OK** and then go to step 4.
- If the two vertical white bars do not appear clearly, press **OK** and then **TV PROG +** or **-** to set the video recorder to a vacant channel between 28 and 60 which is not occupied by any local station in your area.

(Ex.) If channel 50 is available in your area

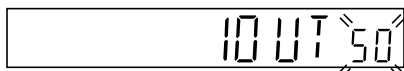

Then set your TV to UHF channel 50 and check if the two vertical white bars appear clearly on the screen; if so, go to step 4. If not, re-set the video recorder to another vacant channel and try again.

### NOTES:

- *If you set the video recorder to a channel which is occupied by a local station or has neighbouring channels that are occupied by local stations, the picture reception quality will be affected and some interference noise will appear on the TV screen. Be sure to select a vacant channel which has no broadcast on neighbouring channels.*
- *If you cannot obtain the two vertical white bars clearly with any channel between 28 and 60, consult your JVC dealer.*

## EXIT VIDEO CHANNEL SET MODE

4

Press **⏏/I** to finish the setting.

## With AV Connection

### IMPORTANT:

Before performing the following steps, make sure the recorder's power is off and there is no cassette inserted in the recorder.

1

## ACCESS VIDEO CHANNEL SET MODE

Hold down **STOP/EJECT** on the recorder until the display panel shows the following.

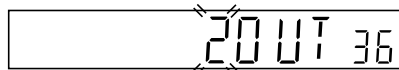

2

## SET VIDEO CHANNEL

Press **OK**, then press **TV PROG -** until the display panel shows the following.

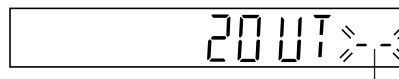

Now the video channel is set to off (- -).

3

## EXIT VIDEO CHANNEL SET MODE

Press **⏏/I** to finish the setting.

To view picture signals from the video recorder, set your TV to its AV mode.

# Auto Set Up

## Auto Channel Set

Before starting, make sure of the following:

- The TV aerial cable should be connected to the recorder.
- The recorder's mains power cord should be connected to a mains outlet. [☞](#) pg. 3
- The "Video Channel Set" procedure should be done first and the TV should be set to its AV mode (with AV connection [☞](#) pg. 5) or video channel (with RF connection [☞](#) pg. 4).

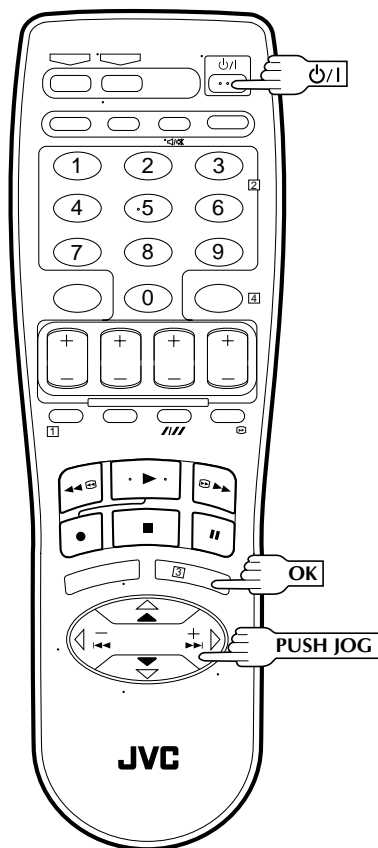
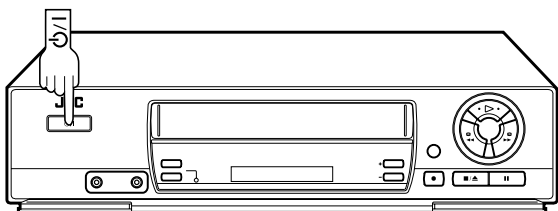

The Auto Set Up function simplifies installation by guiding you through the procedures of setting the language, clock and tuner channels — simply follow the on-screen menus that appear when the **☺/1** button is first pressed to power on the recorder after you plug the mains power cord into a mains outlet.

### IMPORTANT

- Don't press any buttons on the recorder or remote that are not directly related to the step you are performing while Auto Set Up is in progress.
- If you perform Auto Set Up successfully during installation, there's no need to separately perform the Language Select, Clock Set or Channel Set procedures, but if adjustments become necessary they can be performed as follows:
  - To change the selected language [☞](#) pg. 8
  - To reset or adjust the time [☞](#) pg. 9
  - To add/delete channels manually [☞](#) pg. 34 – 35
  - To reset the tuner after moving to a different location [☞](#) pg. 32

## PERFORM AUTO SET UP

Press **☺/1**.

- The Language Select screen appears.

## SELECT LANGUAGE

Press **PUSH JOG**  $\Delta \nabla$  to place the pointer next to your desired language (English or Russian), then press **OK** or **PUSH JOG**  $\triangleright$ .

- The Clock Set screen appears.

## SET TIME

Press **PUSH JOG**  $\Delta \nabla$  to set the time, then press **OK** or **PUSH JOG**  $\triangleright$ .

- Press and hold either button to delay or advance the time by 30 minutes.

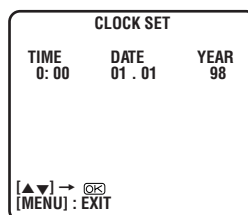

## SET DATE

Press **PUSH JOG**  $\Delta \nabla$  to set the date, then press **OK** or **PUSH JOG**  $\triangleright$ .

- Press and hold either button to change the date by 15 days.

## SET YEAR

Press **PUSH JOG**  $\Delta \nabla$  to set the year, then press **MENU**.

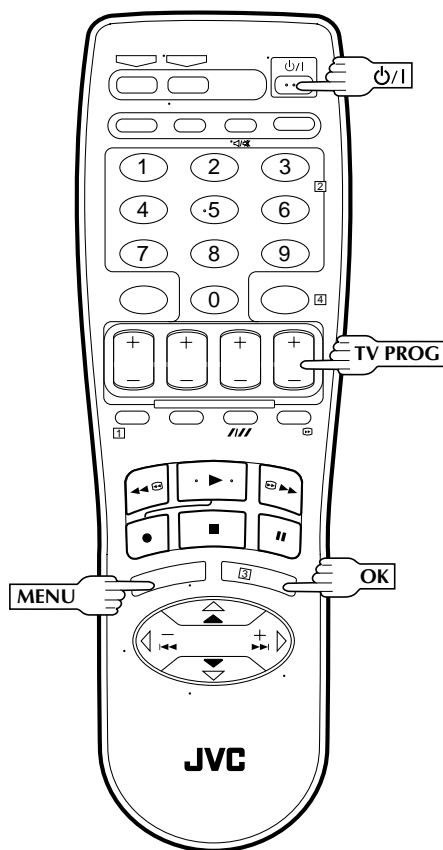
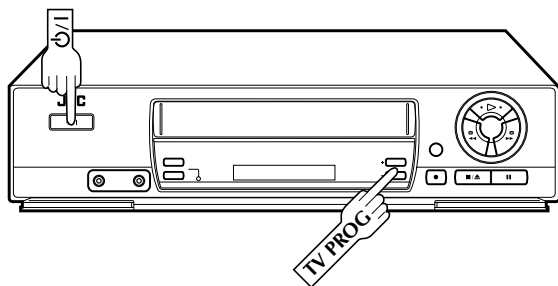

6

## START AUTO CHANNEL SET

Press **MENU** and the "AUTO SET" screen appears. When Auto Channel Set is completed, "SCAN COMPLETED" appears for about 5 seconds on the screen, then the normal screen appears.

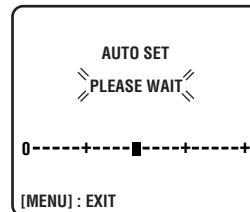

- The Auto Set Up function scans all the channels that are receivable by your recorder. It then automatically assigns each receivable channels to the **TV PROG** buttons. It skips non-receivable channels.
- As Auto Set Up progresses, the "■" mark on the screen moves from left to right.

## ATTENTION

Since the product is designed for use in regions where the D/K TV system is used, Auto Set Up will not work properly in regions where the B/G TV system is used (☞ pg. 34). Please set the tuner manually (☞ pg. 34).

## NOTES:

- If you perform Auto Set Up when the aerial cable is not connected properly, "SCAN COMPLETED -NO SIGNAL-" appears on the screen. When this happens, make sure of the aerial connection and press **OK**; Auto Channel Set will take place again.
- If there is a power cut, or if you press **⏻/|** or **MENU** while Auto Set Up is in progress, Auto Channel Set will be interrupted; be sure to turn off the recorder power once and try again.
- If you want to set the tuner manually such as to add or skip channels, to swap channel positions, or to fine-tune channels, ☞ pg. 34 – 35.
- If no sound accompanies the picture on some channels that have been stored by Auto Set Up, the TV system setting for those channels may be incorrect. Select the appropriate TV system for those channels. ☞ "TV System Selection – When you see the picture but hear no audio" on page 37.

# Select Language

Turn on the TV and select the VIDEO channel (or AV mode).

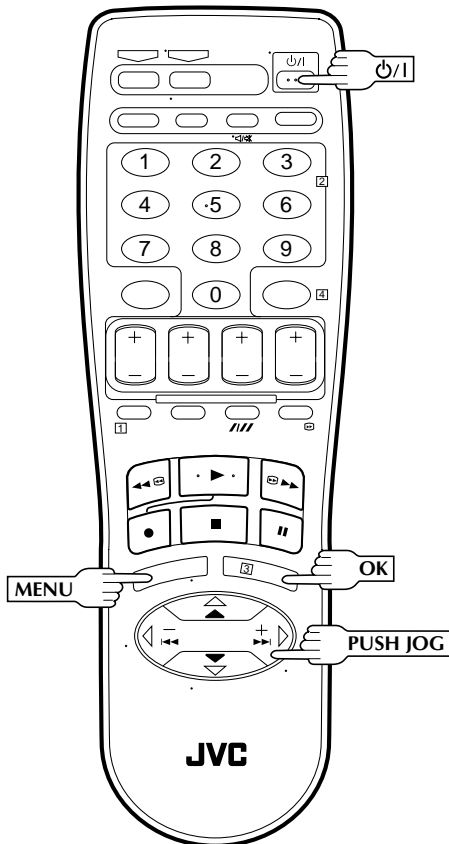

## 1 TURN ON THE RECORDER

Press **ON/OFF**.

## 2 ACCESS MAIN MENU SCREEN

Press **MENU**.

## 3 ACCESS INITIAL SET SCREEN

Press **PUSH JOG**  $\Delta \nabla$  to place the pointer next to "INITIAL SET", then press **OK** or **PUSH JOG**  $\triangleright$ .

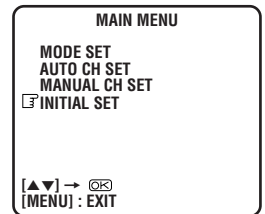

## 4 ACCESS LANGUAGE SELECT SCREEN

Press **PUSH JOG**  $\Delta \nabla$  to place the pointer next to "LANGUAGE", then press **OK** or **PUSH JOG**  $\triangleright$ .

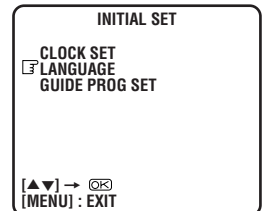

## 5 SELECT LANGUAGE

Place the pointer next to the language of your choice (English or Russian) by pressing **PUSH JOG**  $\Delta \nabla$ , then press **OK** or **PUSH JOG**  $\triangleright$ .

## 6 RETURN TO NORMAL SCREEN

Press **MENU**.



# Clock Set

Turn on the TV and select the VIDEO channel (or AV mode).

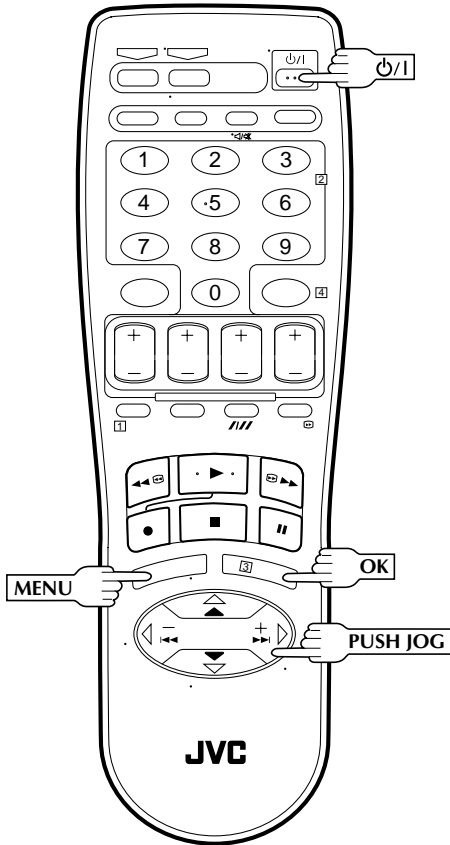

## 1 TURN THE RECORDER ON

Press **⏻/I**.

## 2 ACCESS MAIN MENU SCREEN

Press **MENU**.

## 3 ACCESS INITIAL SET SCREEN

Press **PUSH JOG**  $\Delta\nabla$  to place the pointer next to "INITIAL SET", then press **OK** or **PUSH JOG**  $\triangleright$ .

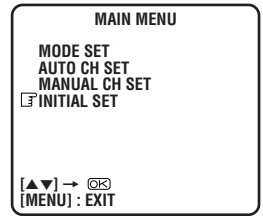

## 4 ACCESS CLOCK SET SCREEN

Press **PUSH JOG**  $\Delta\nabla$  to place the pointer next to "CLOCK SET", then press **OK** or **PUSH JOG**  $\triangleright$ . The Clock Set screen appears.

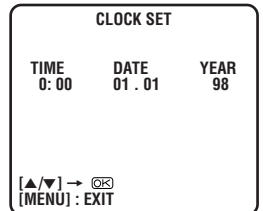
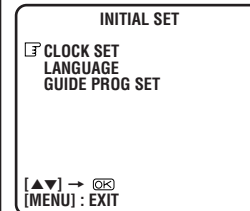

## 5 SET TIME

Press **PUSH JOG**  $\Delta\nabla$  to set the time, then press **OK** or **PUSH JOG**  $\triangleright$ .

- Press and hold either button to delay or advance the time by 30 minutes.

## 6 SET DATE

Press **PUSH JOG**  $\Delta\nabla$  to set the date, then press **OK** or **PUSH JOG**  $\triangleright$ .

- Press and hold either button to change the date by 15 days.

## 7 SET YEAR

Press **PUSH JOG**  $\Delta\nabla$  to set the year.

## 8 START CLOCK OPERATION

Press **MENU**.

### NOTE:

If the year digits are automatically cleared, it is possible that you have input 29th February for a non-leap year. Input the correct data.

# On-Screen Displays

Turn on the TV and select the VIDEO channel (or AV mode).

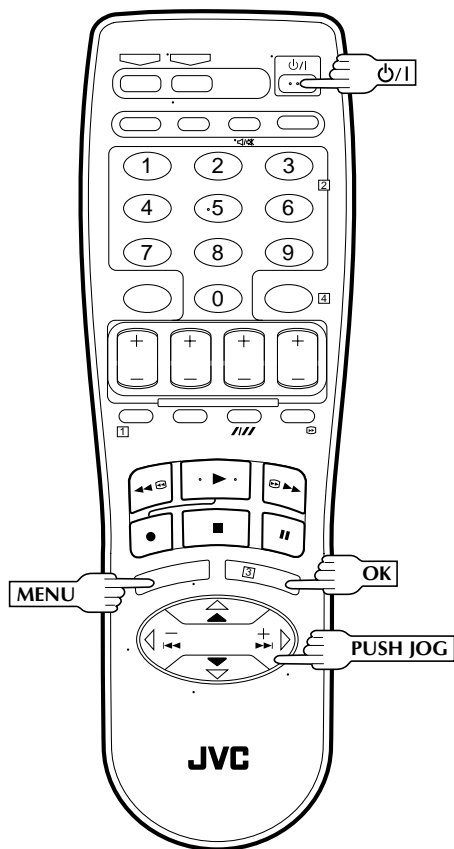

You can choose whether or not to have various operational indicators appear on screen, by setting this function ON or OFF.

## 1 TURN ON THE RECORDER

Press **⏻/I**.

## 2 ACCESS MAIN MENU SCREEN

Press **MENU**.

## 3 ACCESS MODE SET SCREEN

Place the pointer next to "MODE SET" by pressing **PUSH JOG**  $\Delta$ / $\nabla$ , then press **OK** or **PUSH JOG**  $\triangleright$ .

## 4 ENABLE/DISABLE ON-SCREEN DISPLAY

The default setting is "ON", so if you want on-screen displays, leave the setting as it is and go to step 5. If you don't want the displays to appear, press **PUSH JOG**  $\Delta$ / $\nabla$  to place the pointer next to "O.S.D.," and press **OK** or **PUSH JOG**  $\triangleright$  to set to "OFF".

MODE SET	
AUTO TIMER	OFF
<input checked="" type="checkbox"/> O. S. D.	ON
B. E. S. T.	ON
AUTO SP→LP TIMER	OFF
COLOUR SYSTEM	PAL/NTSC

[ $\Delta$ / $\nabla$ ] → [OK]  
[MENU] : EXIT

- "AUTO SP→LP TIMER" appears only with the HR-J459EE.

## 5 RETURN TO NORMAL

Press **MENU**.

### NOTES:

- When you use this recorder as the player for editing, be sure to set "O.S.D." to "OFF" before starting.
- During playback, the operation mode indicators may be disturbed depending on the type of tape being used.

The superimposed indication on the TV screen tells you what the recorder is doing.

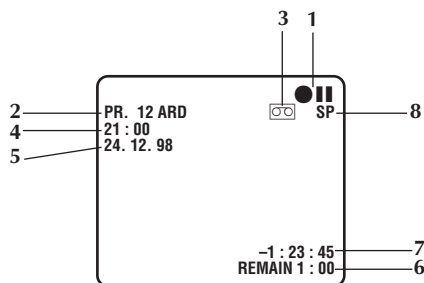

- 1- Operation mode indicators
- 2- Channel position number and station name\*/Aux. indicator (F-1)  
\* Displayed if you have set station names manually (pg. 36, 37).
- 3- Cassette loaded mark
- 4- Clock display
- 5- Current day/month/year
- 6- Tape remaining time indicator (pg. 17)
- 7- Counter display
- 8- Tape speed SP/LP/EP (EP is for NTSC playback only) (HR-J459EE only)

# Colour System Set

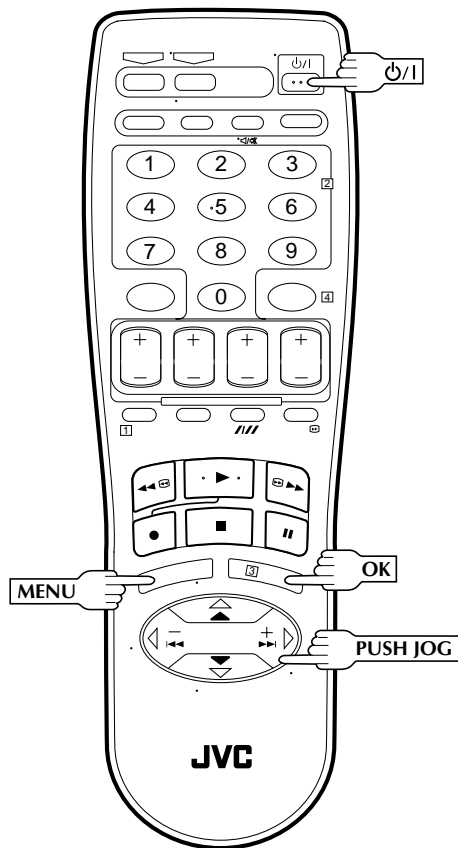

You can play back PAL, NTSC and MESECAM tapes, or record PAL and SECAM\* signals on this recorder. Follow the procedure below to select the appropriate colour system.

\* SECAM signals will be recorded as MESECAM on this recorder; MESECAM is the designation for tapes with SECAM signals that have been recorded on a MESECAM-compatible PAL video cassette recorder.

## TURN ON THE RECORDER

1 Press **Power**.

## ACCESS MAIN MENU SCREEN

2 Press **MENU**.

## ACCESS MODE SET SCREEN

3 Press **PUSH JOG**  $\Delta \nabla$  to place the pointer next to "MODE SET", then press **OK** or **PUSH JOG**  $\triangleright$ .

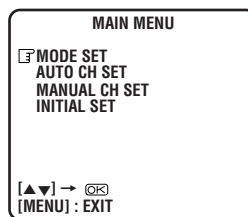

## SELECT COLOUR SYSTEM MODE

4 Press **PUSH JOG**  $\Delta \nabla$  to place the pointer next to "COLOUR SYSTEM", then press **OK** or **PUSH JOG**  $\triangleright$  to select the appropriate colour system.

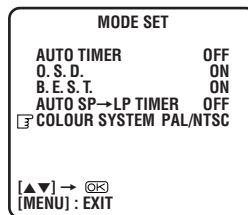

- a- PAL/NTSC: To record PAL signals, or play back a PAL or NTSC tape.
- b- MESECAM: To record SECAM signals, or play back a MESECAM tape.

- "AUTO SP  $\rightarrow$  LP TIMER" appears only with the HR-J459EE.

## RETURN TO NORMAL SCREEN

5 Press **MENU**.

### NOTES:

#### About NTSC Playback

- Some TVs shrink the picture vertically and place black bars at the top and bottom of the screen. This is not a malfunction on the part of either the video recorder or the TV.
- The picture may roll up and down. This can be corrected using the V-HOLD control found on some TVs. (This cannot be corrected if the TV does not have a V-HOLD control.)
- The counter and tape remaining time readings may be incorrect.
- During search, still, or frame-by-frame playback, the picture may be distorted, and there may be a loss of colour.
- Depending on the type of TV, the top and bottom portions of superimposed displays may be cut off during NTSC playback.

# Basic Playback

Turn on the TV and select the VIDEO channel (or AV mode).

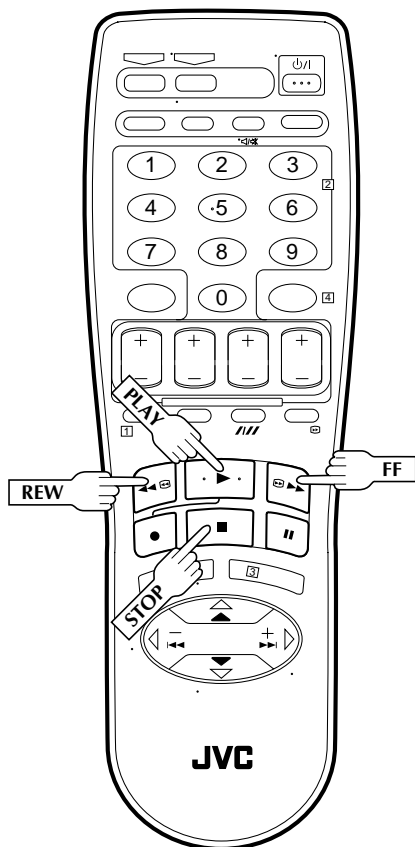
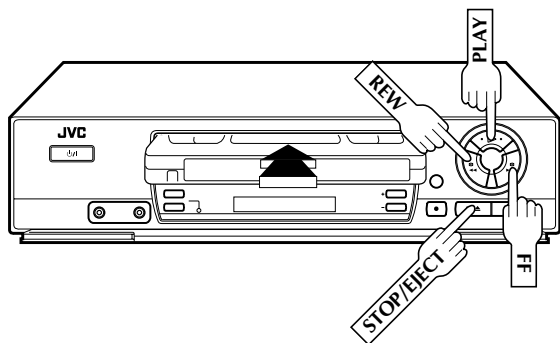

The easiest, most basic operation possible with your video recorder is tape playback. Already-recorded signals on a video tape are read by your video recorder and displayed on your TV just like a TV programme.

1

## LOAD A CASSETTE

Make sure the window side is up, the rear label side is facing you and the arrow on the front of the cassette is point toward the recorder. Don't apply too much pressure when inserting.

- The recorder power comes on automatically and the counter is reset to 0:00:00.
- If the record safety tab has been removed, playback begins automatically. (☞ pg. 16)

2

## FIND PROGRAMME START POINT

If the tape is advanced past the start point, press **REW**. To go forward, press **FF**.

3

## START PLAYBACK

Press **PLAY**. "BEST" appears blinking in the recorder's display panel during automatic tracking. (☞ pg. 18)

4

## STOP PLAYBACK

Press **STOP** on the remote or **STOP/EJECT** on the recorder's front panel. Then press **STOP/EJECT** to remove the cassette.

### Usable cassettes

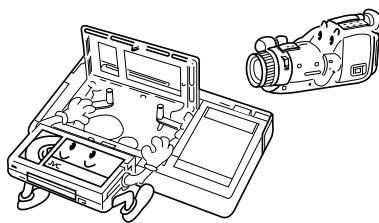

- Compact VHS camcorder recordings can be played on this video recorder. Simply place the recorded cassette into a VHS Cassette Adapter and it can be used just like any full-sized VHS cassette.
- This video recorder can record on regular VHS and Super VHS cassettes. However, it will record and play back regular VHS signals only. It is not possible to play back a recorded Super VHS tape.

# Playback Features

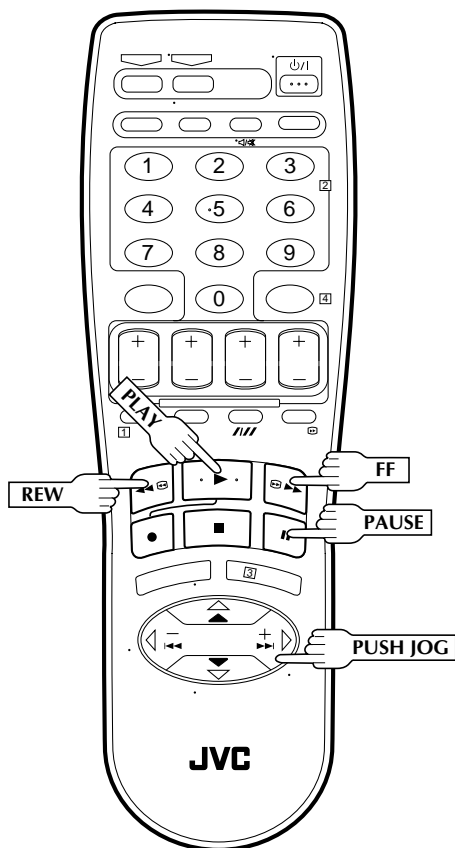
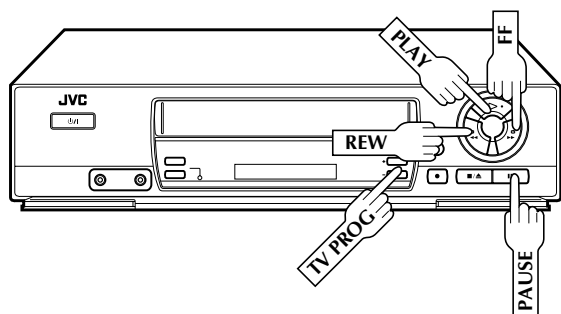

## ATTENTION

In the search, still, slow-motion or frame-by-frame playback mode,

- the picture will be distorted.
- the noise bars will appear.
- there will be a loss of colour with an LP-recorded tape (HR-J459EE only).

## Variable-Speed Search

### 1 ACTIVATE VARIABLE-SPEED SEARCH

During playback, press **PUSH JOG** ◀ or ▶.

- The more times you press, the faster the playback picture moves.
- To decrease speed, press the button for the opposite direction.

To resume normal playback, press **PLAY**.

## Still Picture/Frame-By-Frame Playback

### 1 PAUSE DURING PLAYBACK

Press **PAUSE**. If there is vertical jitter, use the **TV PROG** buttons to correct the picture.

### 2 ACTIVATE FRAME-BY-FRAME PLAYBACK

Press **PAUSE**.

**OR**

Press **PUSH JOG** ◀ or ▶.

To resume normal playback, press **PLAY**.

## Slow Motion

### 1 ACTIVATE SLOW-MOTION PLAYBACK

During still picture, press and hold **PAUSE** for 2 seconds, then release. Press and release again to return to still picture.

**OR**

During still picture, press and hold **PUSH JOG** ◀ or ▶. Release to return to still picture.

To resume normal playback, press **PLAY**.

## High-Speed Search

### 1 ACTIVATE HIGH-SPEED SEARCH

During playback or still, press **FF** for forward high-speed search, or **REW** for reverse high-speed search.

To resume normal playback, press **PLAY**.

## NOTE:

For short searches, press and hold **FF** or **REW** for over 2 seconds. When released, normal playback resumes.

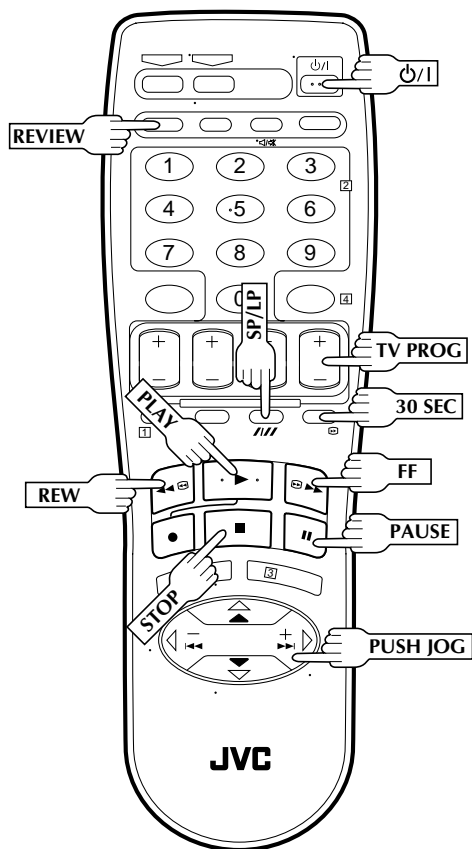

## Manual Tracking

Your video recorder is equipped with automatic tracking control. During playback, you can override this and adjust the tracking manually by pressing the **TV PROG** buttons.

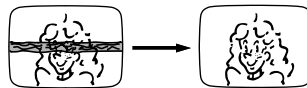

### 1 OVERRIDE AUTOMATIC TRACKING

Press **SP/LP** (SP/LP) on the remote to engage manual tracking.

### 2 ADJUST TRACKING MANUALLY

Press **TV PROG +** or **-** to adjust tracking.

### 3 RETURN TO AUTOMATIC TRACKING

Press **SP/LP** (SP/LP) on the remote to re-engage automatic tracking.

#### NOTE:

When a new tape is inserted, the recorder enters the automatic tracking mode automatically.

## Repeat Playback

Your video recorder can automatically play back the whole tape 50 times repeatedly.

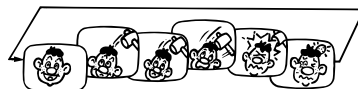

### 1 START PLAYBACK

Press **PLAY**.

### 2 ACTIVATE REPEAT PLAYBACK

Press **PLAY** and hold for over 5 seconds, then release.

- The Play indicator (▶) on the display panel blinks slowly.
- The tape plays 50 times automatically, and then stops.

### 3 STOP PLAYBACK

Press **STOP** at any time to stop playback.

#### NOTE:

Pressing **PLAY**, **REW**, **FF** or **PAUSE** also stops Repeat Playback.

## Index Search

Your recorder automatically marks index codes at the beginning of each recording. This function gives you quick access to any one of 9 index codes in either direction.

### NOTE:

Before starting, make sure the recorder is in the Stop mode.



## 1 ACTIVATE INDEX SEARCH

Press **PUSH JOG** ◀ or ▶ (◀◀◀ or ▶▶▶) on the remote control. "◀◀◀ 1" or "▶▶▶ 1" is displayed on screen and search begins in the corresponding direction.

- To access index codes 2 through 9, press **PUSH JOG** ◀ or ▶ repeatedly until the correct index number is displayed.

Ex.: To locate the beginning of B from the current position, press **PUSH JOG** ◀ twice.  
To locate the beginning of D from the current position, press **PUSH JOG** ▶ once.

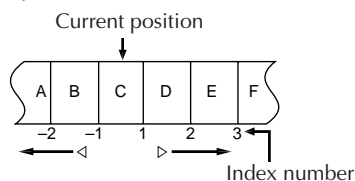

- When the specified index code is located, playback begins automatically.

## Next Function Memory

You can set your recorder's power to go off automatically after the tape is fully rewound. Before starting, make sure the recorder is in the Stop mode.

For Automatic Power Off After Tape Rewind . . .  
. . . press **REW**, then press **⏻** within 2 seconds.

## Skip Search

### SKIP OVER UNWANTED SECTIONS

1 Press **30 SEC 1** to 4 times during playback. Each press initiates a 30-second period of fast-motion playback. Normal playback resumes automatically.

### NOTE:

To return to normal playback during a Skip Search, press **PLAY**.

## Instant ReView

Simply by pressing a single button, the recorder power comes on, rewinds, and begins playback of the last timer-recorded programme. If you have several programmes recorded, you can easily access any of them.

### NOTE:

Before starting, make sure that the recorder is off and that the Timer mode is disengaged.

## 1 ACTIVATE INSTANT REVIEW

Press **REVIEW**. The recorder power comes on and the recorder searches for the index code indicating the start of the last timer-recorded programme. Once it's found, playback begins automatically.

- The front display panel tells you how many programmes have been recorded. If you have, for example, 3 programmes, "REVIEW" and "3" appear and blink. To watch the first of the 3 programmes, press **REVIEW** three times. The recorder searches and begins playback automatically. You can access a programme as far as 9 index codes away from the current tape position.

### NOTES:

- Instant ReView is not possible while the recorder is in the Timer mode.
- The number of recorded programmes will not be displayed on the front display panel after Auto Satellite Prog recording (☞ pg. 28).

# Basic Recording

Turn on the TV and select the VIDEO channel (or AV mode).

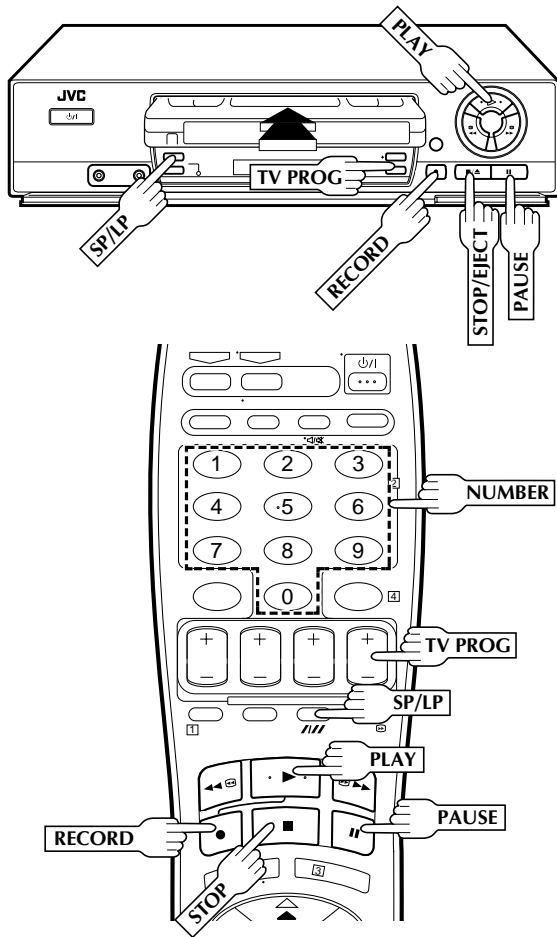

## Accidental erasure prevention

- To prevent accidental recording on a recorded cassette, remove its safety tab. To record on it later, cover the hole with adhesive tape.

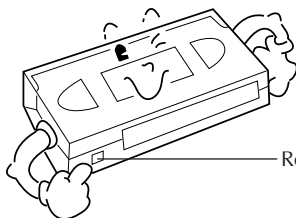

Record safety tab

TV signals being received by the recorder's built-in tuner can be recorded onto a video tape. You can "capture" a TV programme using your video recorder.

## 1 LOAD A CASSETTE

Insert a cassette with the record safety tab intact.

- The counter is reset to 0:00:00 and the recorder power comes on automatically.

## 2 CHOOSE A PROGRAMME

Press **TV PROG +/-** or the **NUMBER** keys to select the channel you wish to record.

## 3 SET TAPE SPEED (HR-J459EE ONLY)

Press **///** (**SP/LP**). Check the SP/LP indicator on the recorder display panel to confirm the selected tape speed.

## 4 START RECORDING

Press and hold **RECORD** and **PLAY** on the remote control, or press **RECORD** on the recorder.

### With HR-J459EE:

B.E.S.T. takes place at the beginning of both the first SP and the first LP recording after inserting the cassette (see pg. 18).

### With HR-J259EE:

B.E.S.T. takes place at the beginning of the first recording after inserting the cassette (see pg. 18).

## 5 PAUSE/RESUME RECORDING

Press **PAUSE**. Press **PLAY** to resume recording.

## 6 STOP RECORDING

Press **STOP** on the remote control or **STOP/EJECT** on the recorder. Then press **STOP/EJECT** to remove the cassette.

## Recording Resume Function

If there is a power outage during recording (or Instant Timer Recording or timer recording), the recording will resume automatically when power is restored to the recorder unless the recorder's memory backup has expired.



# Recording Features

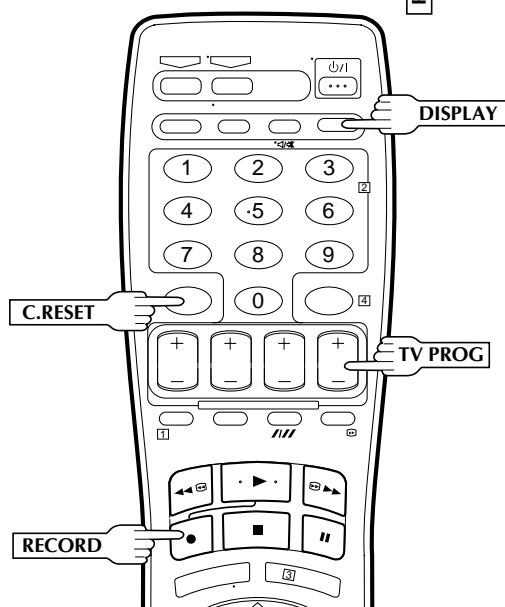
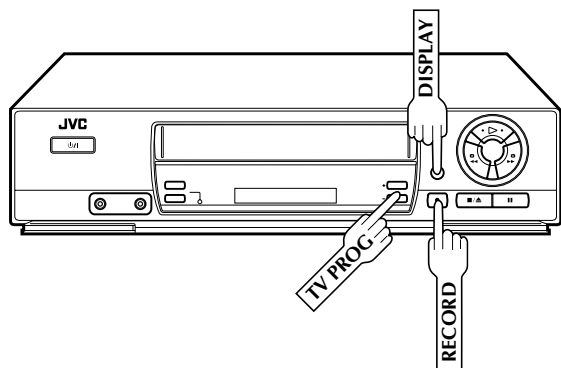

## Tape Remaining Time

### 1 DISPLAY REMAINING TIME

Press **DISPLAY** until the time remaining on the tape appears.

- The display panel shows the tape remaining time with "▶" displayed.
- By pressing the **DISPLAY** button, you can change the display to show the counter reading, channel position\*, clock time or tape remaining time.  
\* channel position is not displayed during playback.

### NOTE:

Depending on the type of tape used, there may be times when the tape remaining time reading may not appear right away, or is not correct. "--:--" may sometimes appear, or the display may blink on occasion.

## Record One Programme While Watching Another

### 1 SELECT CHANNEL TO WATCH

Once recording is in progress, all you need to do is to set the channel controls on the TV for the station you wish to view.

- The programme selected with the TV's channel controls appears on the TV screen while the one selected with the **TV PROG** buttons is recorded on the tape.

## Elapsed Recording Time Indication

You can check the exact time of a recording.

### 1 SET COUNTER DISPLAY

Press **DISPLAY** until a counter reading appears on the display panel.

### 2 RESET COUNTER

Press **C. RESET** before starting recording or playback.

- The counter is reset to "0:00:00" and shows the exact elapsed time as the tape runs.
- The HR-J259EE owners can use the **COUNTER RESET** button on the recorder's front panel as well.

## Instant Timer Recording (ITR)

This easy method lets you record for from 30 minutes to 6 hours (selectable in 30-min. increments), and shuts the recorder off after recording is finished.

### 1 START RECORDING

Press **RECORD** on the recorder.

### 2 ENGAGE ITR MODE

Press **RECORD** again. "⦿" blinks and 0:30 appears on the front display panel.

### 3 SET RECORDING DURATION

If you want to record for more than 30 minutes, press **RECORD** to extend the time. Each press extends recording time by 30 minutes.

### NOTES:

- You can only perform ITR using the **RECORD** button on the recorder's front panel.
- After you set the ITR time, the counter display appears.
- To check the remaining time, press **RECORD** once during recording and the remaining time will be displayed for about 5 seconds. Be careful not to press **RECORD** again within these 5 seconds, or you will round the recording time up to the next 30 minute increment.

# B.E.S.T. Picture System

Turn on the TV and select the VIDEO channel (or AV mode).

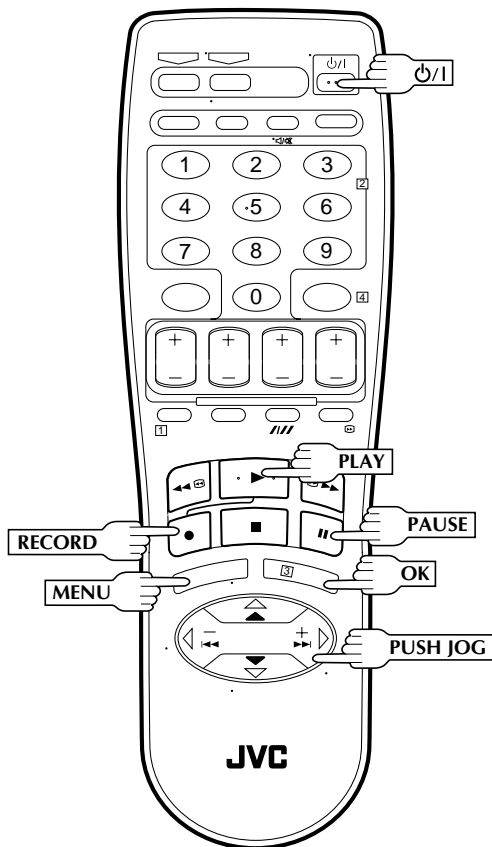
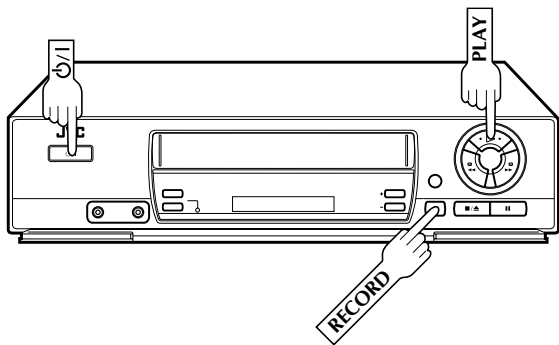

The B.E.S.T. (Biconditional Equalised Signal Tracking) system checks the condition of the tape in use during recording and playback, and compensates to provide the highest-possible recording and playback pictures. The default setting for both recording and playback is "ON".

## Preparation

### 1 TURN THE RECORDER ON

Press  $\text{P}/\text{I}$ .

### 2 ACCESS MAIN MENU SCREEN

Press MENU.

### 3 ACCESS MODE SET SCREEN

Place the pointer next to "MODE SET" by pressing **PUSH JOG**  $\Delta/\nabla$ , then press **OK** or **PUSH JOG**  $\triangleright$ .

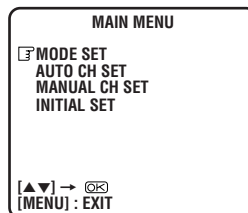

### 4 SELECT MODE

Place the pointer next to "B.E.S.T." by pressing **PUSH JOG**  $\Delta/\nabla$ , then press **OK** or **PUSH JOG**  $\triangleright$  to set to "ON" or "OFF".

- "AUTO SP $\rightarrow$ LP TIMER" appears only with the HR-J459EE.

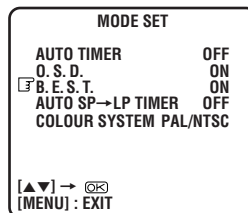

### 5 RETURN TO NORMAL SCREEN

Press MENU.

## Recording

### START RECORDING

**1** Press and hold **RECORD** and press **PLAY** on the remote, or press **RECORD** on the recorder.

**DURING B.E.S.T.**



**B.E.S.T. COMPLETE**

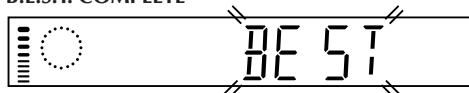

- The recorder spends approximately 7 seconds assessing the condition of the tape, then begins recording.

### NOTES:

- **With HR-J459EE:**  
The B.E.S.T. system works for both SP and LP modes only after a tape has been inserted and the Record mode is first initiated. It does not work during recording.
- **With HR-J259EE:**  
The B.E.S.T. system works only after a tape has been inserted and the Record mode is first initiated. It does not work during recording.
- The B.E.S.T. system does not work while Auto Satellite Prog recording is in progress (☞ pg. 28).
- In the case of timer recording, the B.E.S.T. system works before recording is initiated.
- Once the cassette is ejected, the B.E.S.T. data is cancelled. The next time the cassette is used for recording, B.E.S.T. is re-performed.
- Pressing the recorder's **RECORD** button while "BEST" is displayed does not start Instant Timer Recording (☞ pg. 17).

### ATTENTION

*Since the B.E.S.T. system works before recording actually starts, there is a delay of approximately 7 seconds after **RECORD** and **PLAY** on the remote are pressed, or **RECORD** on the recorder is pressed. To make sure you record the desired scene or programme in its entirety, first perform the following steps:*

- 1) Press and hold **PAUSE** and press **RECORD** to engage the RECORD PAUSE mode.
  - The recorder then automatically checks the condition of the tape and, after approximately 7 seconds, re-enters RECORD PAUSE.
- 2) Press **PLAY** to start recording.
  - If you want to bypass the B.E.S.T. system and begin recording immediately, set "B.E.S.T." to "OFF" in step 4 on page 18.

## Playback

The recorder assesses the quality of the tape once you initiate playback.

### START PLAYBACK

**1** Press **PLAY**.

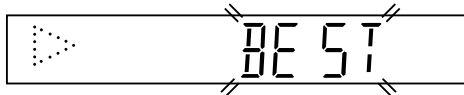

- The recorder adjusts the playback picture quality based on the quality of the tape in use.
- B.E.S.T. is active during Auto Tracking. "BEST" appears blinking on the recorder's display panel.

### NOTES:

- When watching a tape recorded with "B.E.S.T." set to "ON", it is recommended that you leave B.E.S.T. on during playback as well.
- When watching a rental tape or one recorded on another video recorder, or when using this recorder as the player for editing, set B.E.S.T. to your preference by performing steps 1 through 5 on page 18.
- "BEST" only appears at the beginning of automatic tracking. Even though it doesn't appear after that, the B.E.S.T. function is operative.

# SHOWVIEW Setup

Turn on the TV and select the VIDEO channel (or AV mode).

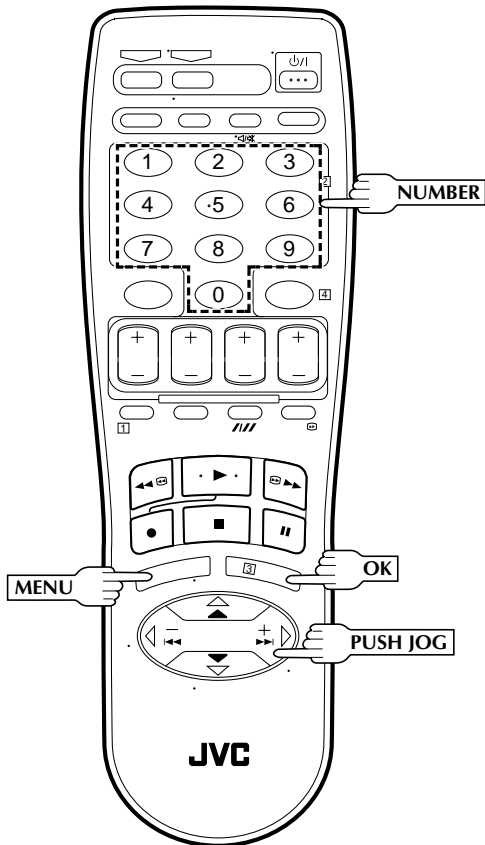

## ATTENTION

For a list of Guide Prog. Numbers for Poland, Czech Republic, Hungary, and Russia, refer to page 42 of the instruction manual printed in the corresponding language.

The SHOWVIEW timer programming system eliminates the need to input channel, date, start and stop time data when setting the timer record function. Simply key in the SHOWVIEW number for the TV program you wish to record (found in most TV listings) and the recorder's timer is automatically programmed.

You have to set "GUIDE PROG" numbers, which are assigned to each station for purposes of SHOWVIEW timer programming, for all the stations stored in your recorder's memory to get proper results.

Before SHOWVIEW setup you must have performed the following procedures:

- Tuner setting (☞ pg. 6, 32)
- Clock setting (☞ pg. 6, 9)

## IMPORTANT

Perform the following procedure after Auto Set Up on page 6 and/or the channel setting steps on pages 32 - 37. After setting the Guide Program Numbers, channel positions may be incorrect if you stored or skipped channels. In this case, re-perform Guide Program Number setting.

## Guide Program Number Set

### 1 ACCESS MAIN MENU SCREEN

Press **MENU**.

### 2 ACCESS INITIAL SET SCREEN

Press **PUSH JOG**  $\Delta$ / $\nabla$  to place the pointer next to "INITIAL SET", then press **OK** or **PUSH JOG**  $\triangleright$ .

### 3 ACCESS GUIDE PROG SET SCREEN

Press **PUSH JOG**  $\Delta$ / $\nabla$  to place the pointer next to "GUIDE PROG SET", then press **OK** or **PUSH JOG**  $\triangleright$ .

### 4 ENTER GUIDE PROG NUMBER

Press **PUSH JOG**  $\Delta$ / $\nabla$  or **NUMBER** keys to enter the Guide Program number for the desired station as shown in the TV listings. Then press **OK** or **PUSH JOG**  $\triangleright$ .

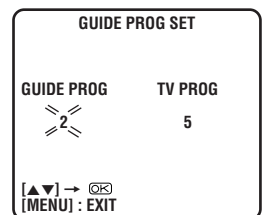

(Ex.) When inputting the Guide Program number 2 for RTR.

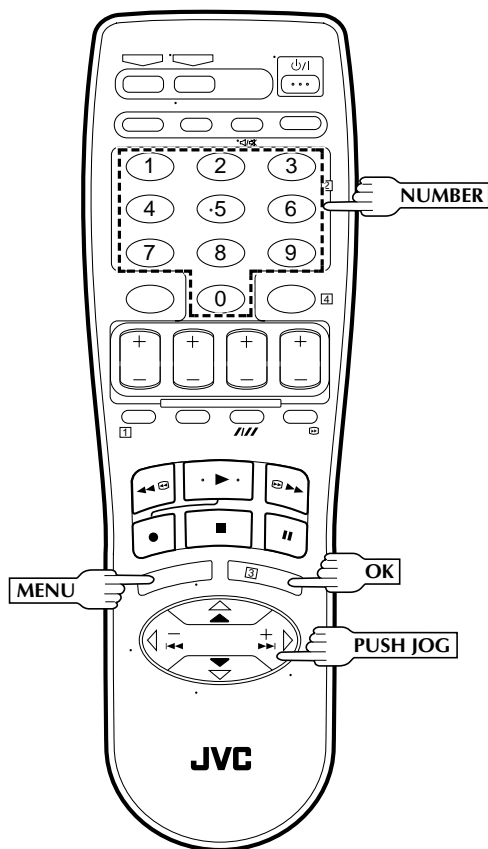

## ENTER RECEIVING CHANNEL POSITION NUMBER

5

Press **PUSH JOG**  $\Delta \nabla$  or **NUMBER** keys to input the number of the recorder's channel position on which the Guide Program number's broadcast is received. Then press **OK** or **PUSH JOG**  $\triangleright$ .

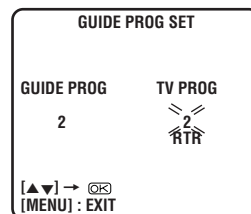

- If the satellite broadcast is received on your recorder's auxiliary channel "F-1", select "F-1" for the channel position.
  - Repeat steps 4 and 5 as necessary.
- (Ex.) If RTR is received on channel position 2.

## RETURN TO NORMAL SCREEN

6

Press **MENU**.

### Guide Program Number

"Guide Program (GUIDE PROG) number" refers to the assigned TV station numbers, according to broadcast area, for SHOWVIEW timer recording. The Guide Program numbers can be found in most TV listings.

# SHOWVIEW Timer Programming

## Before performing SHOWVIEW Timer Programming:

- Be sure to read "SHOWVIEW Setup" (pg. 20).
- Insert a cassette with the safety tab in place. The recorder will come on automatically.
- Turn on the TV and select the VIDEO channel (or AV mode).

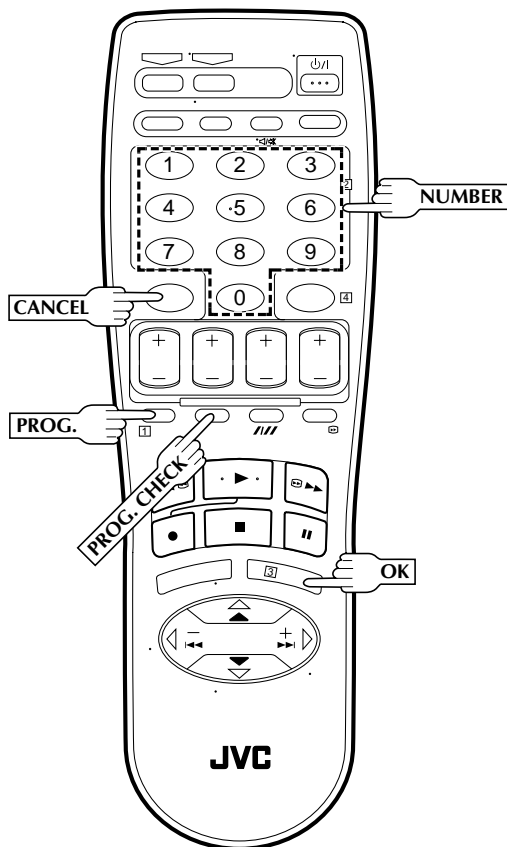

1

## ACCESS SHOWVIEW SCREEN

Press **PROG.**.

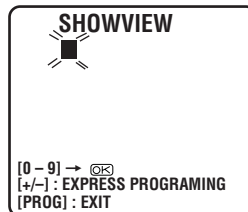

The front display panel looks like this:

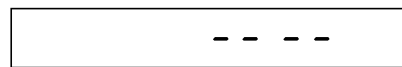

2

## ENTER SHOWVIEW NUMBER

Press the **NUMBER** keys to enter the SHOWVIEW number of a programme you wish to record.

- If you make a mistake, press **CANCEL** and input the correct number.

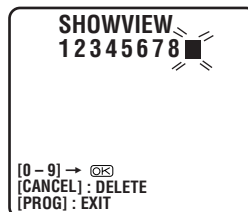

The SHOWVIEW number you enter appears on the front display panel:

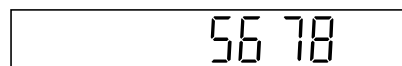

The display panel can show only a 4-digit number.

## ACCESS SHOWVIEW PROGRAM SCREEN

Press **OK**, and the SHOWVIEW Program screen appears (if you're just starting out, "P1" appears).

The display panel shows the programme start time.

Pressing **PROG. CHECK** changes the display to the programme stop time, then the date and channel position.

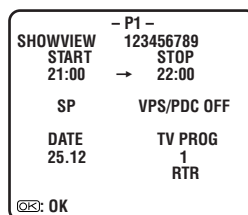

"SP" is not displayed with the HR-J259EE.

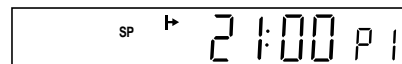

### IMPORTANT

Make sure the channel position number you wish to record is displayed; if not, see "SHOWVIEW Setup" on page 20 and set the Guide Program number for that SHOWVIEW number correctly.

- If the number you entered is invalid, "ERROR" appears on the screen and "Err" appears on the display panel. Press **CANCEL** and input a valid SHOWVIEW number.
- If the "GUIDE PROG SET" screen appears, see "ATTENTION – Regarding Guide Program Number Set" on page 23.

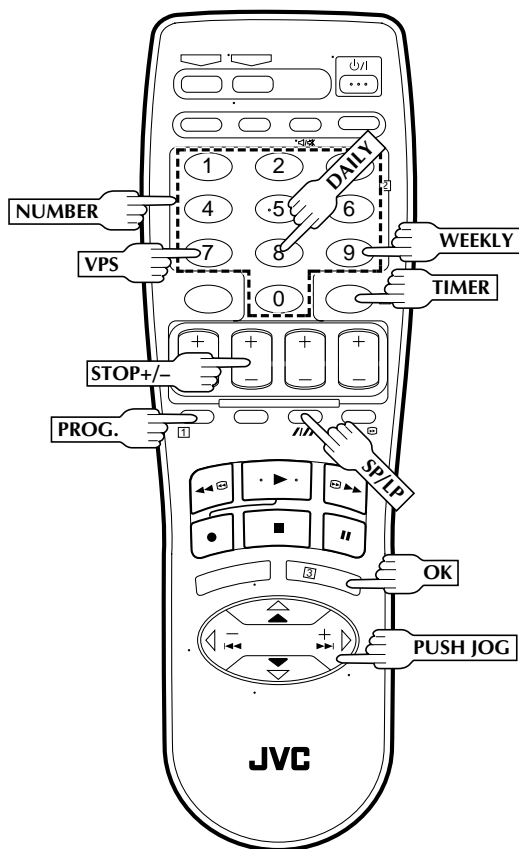

## 4 SET TAPE SPEED (HR-J459EE ONLY)

Press **SP/LP** ( ) to set the tape speed.

## 5 SET VPS MODE

Press **VPS** (**NUMBER** key "7") to select "ON" or "OFF".  
 If "VPS/PDC OFF" is displayed on the screen or "VPS/PDC" is lit on the display panel, VPS is set to OFF.  
 If "VPS/PDC ON" is displayed on the screen or "VPS/PDC" is not lit on the display panel, VPS is set to ON.  
 ☞ "VPS Recording" on page 25.

- PDC (Programme Delivery Control) recording is not possible with this recorder.

## 6 RETURN TO NORMAL SCREEN

Press **PROG.** or **OK**. "PROGRAM COMPLETED" appears on the screen for about 5 seconds, then normal screen appears.

- Repeat steps 1 – 6 for each additional programme.

## 7 ENGAGE RECORDER'S TIMER MODE

Press **TIMER**. The recorder turns off automatically and appears on the display panel.

- To disengage the timer, press **TIMER** again.

## NOTES:

- To Change The Stop Time . . .  
 . . . press **STOP +/-** after pressing **OK** in step 3. You can compensate for anticipated programme schedule delays this way.
- To Timer-Record Weekly Or Daily Serials . . .  
 . . . after pressing **OK** in step 3, press **WEEKLY** (**NUMBER** key "9") for weekly serials or **DAILY** (**NUMBER** key "8") for daily serials (Monday – Friday). Either "WEEKLY" or "DAILY" appears on the screen. Pressing the button again makes the corresponding indication disappear.
- You can programme this recorder to timer-record as many as 8 programmes. If you try to programme the recorder to record a ninth, "PROGRAM FULL" appears on screen and "FULL" appears on the front display panel. To record the extra programme, you must first cancel any unnecessary programmes (☞ pg. 26).
- It is not possible to timer-record a TV programme with a SHOWVIEW number which starts with "0".

## ATTENTION

### Regarding Guide Program Number Set

"GUIDE PROG SET" appears after performing step 3 if the Guide Program number for the SHOWVIEW number you entered has not been set.

- Press the **NUMBER** keys or **PUSH JOG**  $\Delta \nabla$  to input the channel position number on which your recorder receives that station, then press **OK** or **PUSH JOG**  $\triangleright$ . The SHOWVIEW program screen appears.

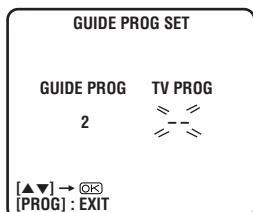

(Ex.) To timer-record a RTR programme with SHOWVIEW.  
 \* If your recorder receives RTR on the channel position 2, press **OK** or **PUSH JOG**  $\triangleright$  after entering "2".

### Satellite Tuner Users

To timer-record a satellite broadcast using SHOWVIEW:

- 1 Perform steps 1 – 7.
- 2 Set the satellite tuner to the appropriate channel before the selected programme begins.
- 3 Leave the satellite tuner's power on.

# Express Timer Programming

## Before performing Express Timer Programming:

- Make sure that the recorder's built-in clock is set properly.
- Insert a cassette with the safety tab in place. The recorder will come on automatically.
- Turn on the TV and select the VIDEO channel (or AV mode).

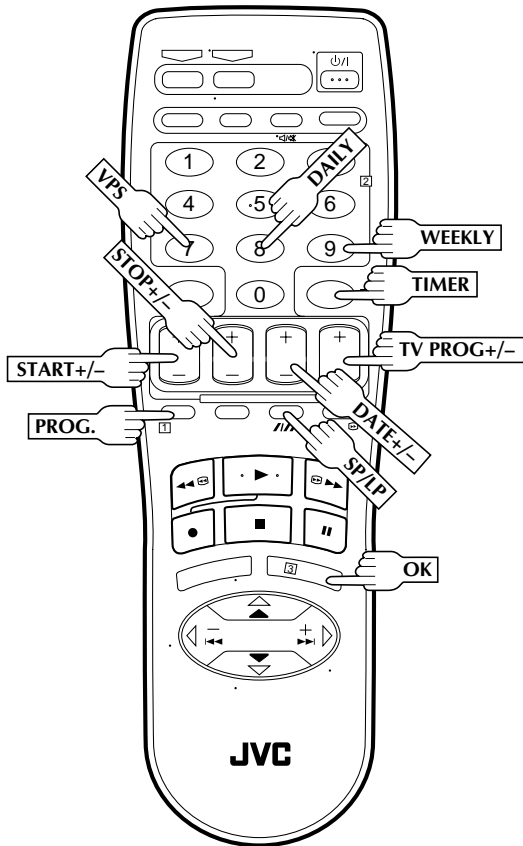

If you don't know the SHOWVIEW number for the programme you wish to record, use the following procedure to set your recorder to timer-record the programme.

## 1 ACCESS SHOWVIEW SCREEN

Press **PROG.**.

## 2 ACCESS PROGRAMME SCREEN

Press **START +/-**. (If you're just starting out, "P1" appears.)

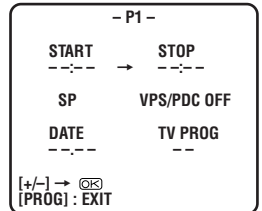

The front display panel looks like this:

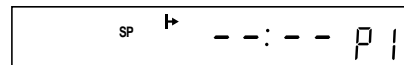

"SP" is not displayed with the HR-J259EE.

## 3 ENTER PROGRAMME START TIME

Press **START +/-** to enter the time you want recording to start.

- Press and hold **START +/-** to move in 30-minute increments, or press and release repeatedly to move 1 minute at a time.

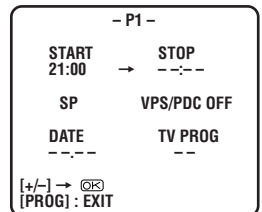

The front display panel looks like this:

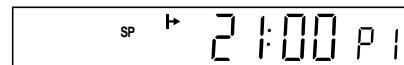

## 4 ENTER PROGRAMME STOP TIME

Press **STOP +/-** to enter the time you want recording to stop.

- Press and hold **STOP +/-** to move in 30-minute increments, or press and release repeatedly to move 1 minute at a time.

## 5 ENTER PROGRAMME DATE

Press **DATE +/-**. (The current date appears on screen. The date you enter appears in its place.)



6

## ENTER CHANNEL POSITION

Press **TV PROG +/-**.

- P1 -	
START 21:00	→ STOP 22:00
SP	VPS/PDC OFF
DATE 25.12	TV PROG 1 RTR
[+/-] → [OK] [PROG] : EXIT	

SP 25 12 1

7

## SET TAPE SPEED (HR-J459EE ONLY)

Press **SP/LP (||||)** to set the tape speed.

8

## SET VPS MODE

Press **VPS** (NUMBER key "7") to select "ON" or "OFF".  
If "VPS/PDC OFF" is displayed on the screen or "VPS/PDC" is lit on the display panel, VPS is set to OFF.  
If "VPS/PDC ON" is displayed on the screen or "VPS/PDC" is not lit on the display panel, VPS is set to ON.  
☒ "VPS Recording" in the right column.

- PDC (Programme Delivery Control) recording is not possible with this recorder.

9

## RETURN TO NORMAL SCREEN

After confirming all information is correct, press **PROG.** or **OK**. "PROGRAM COMPLETED" appears on the screen for about 5 seconds, then normal screen appears.

- Repeat steps 1 – 9 for each additional programme.

10

## ENGAGE RECORDER'S TIMER MODE

Press **TIMER**. The recorder turns off automatically and ☒ appears on the display panel.

- To disengage the timer, press **TIMER** again.

### Satellite Tuner Users

To timer-record a satellite broadcast using Express Timer Programming:

- 1 Perform steps 1 – 10. Enter "F-1" for the channel position in step 6.
- 2 Set the satellite tuner to the appropriate channel before the selected programme begins.
- 3 Leave the satellite tuner's power on.

## VPS Recording

Now available from some TV stations, VPS (Video Programme System) is a service designed to assure safe, accurate timer recording. With this system, special code signals are transmitted together with the audio/video signals. These code signals control your video recorder and have precedence over the advertised times you may have preset into the timer. This means that your recorder will start and stop recording when the preset TV programmes actually start and end — even if the broadcast time of a preset TV programme is changed.

### NOTE:

When you use Express Timer Programming, set the start time (VPS time) exactly as advertised in the TV listing. A different time than advertised will result in no recording.

To Timer-Record Weekly Or Daily Serials . . .

. . . anytime during steps 2 through 9, press **WEEKLY** (NUMBER key "9") for weekly serials or **DAILY** (NUMBER key "8") for daily serials (Monday – Friday). Either "WEEKLY" or "DAILY" appears on the screen. Pressing the button again makes the corresponding indication disappear.

### NOTE:

You can programme this recorder to timer-record as many as 8 programmes. If you try to programme the recorder to record a ninth, "PROGRAM FULL" appears on screen and "FULL" appears on the front display panel. To record the extra programme, you must first cancel any unnecessary programmes (☒ pg. 26).

## Check, Cancel And Replace Programmes

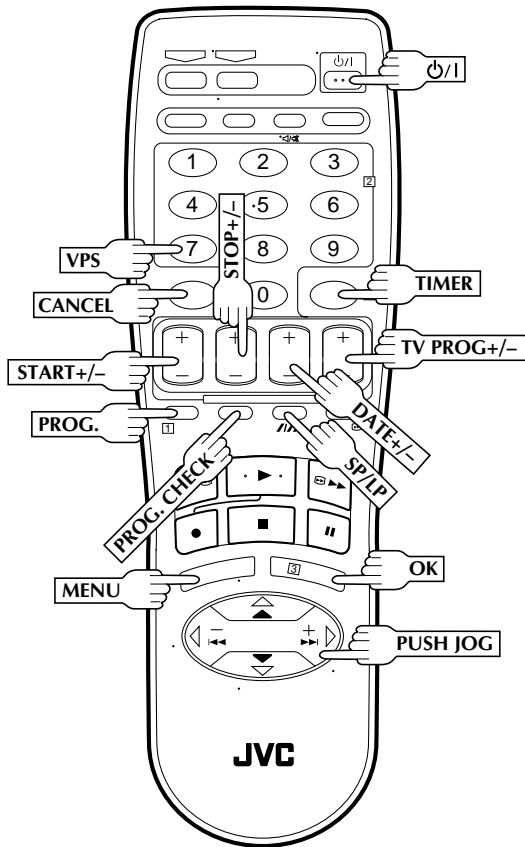

### 1 DISENGAGE TIMER MODE

Press **TIMER**, then press **⏻/I**.

### 2 ACCESS PROGRAM CHECK SCREEN/DISPLAY

Press **PROG. CHECK**.

PR	START	STOP	CH	DATE
1	8:00	10:00	3	24.12
2	10:00	10:45	2	25.12
3	11:30	13:00	1	25.12
4				
5				
6				
7				
8				

[PROG CHECK] : NEXT

PIPB

### 3 ACCESS PROGRAM SCREEN/DISPLAY

Press **PROG. CHECK** again to check more information. Each time you press **PROG. CHECK**, the next programme's information appears.

"SP" is not displayed with the HR-J259EE.

- P1 -	
START 8:00	STOP 10:00
SP	VPS/PDC OFF
DATE 24.12	TV PROG 1 RTR

[PROG CHECK] : NEXT

SP 8:00 P1

- The display panel shows the programme start time. Pressing **OK** changes the display to the programme stop time, then the date and the channel position.

## To cancel or replace a programme...

### 4 CANCEL OR REPLACE A PROGRAMME

Press **CANCEL** to cancel a programme. To replace a programme, press the appropriate button: **START+/-**, **STOP+/-**, **DATE+/-**, **TV PROG+/-**, **VPS**, **SP/LP** (J459EE only).

### 5 RETURN TO NORMAL SCREEN/DISPLAY

Press **PROG. CHECK** as many times as necessary. If there are still some programmes remaining, go on to step 6.

### 6 RETURN TO TIMER MODE

Press **TIMER**.

## NOTE:

You can also check the programmes on the display panel even if the recorder's power is off or the recorder is in the Timer mode; however, it is not possible to cancel or replace the programmes.

## Auto SP→LP Timer (HR-J459EE only)

If, when timer-recording in SP mode, there is not enough tape to record the entire programme, the recorder automatically switches to LP mode to allow complete recording.

### For Example . . .

Recording a PAL-broadcast programme of 210 minutes in length onto a 180-minute tape.

Approximately 150 minutes      Approximately 60 minutes

SP mode	LP mode
---------	---------

Total 210 minutes

Make sure you set "AUTO SP→LP TIMER" to "ON" at the Mode Set screen before the timer-recording starts.

### 1 ACCESS MAIN MENU SCREEN

Press **MENU**.

### 2 ACCESS MODE SET SCREEN

Press **PUSH JOG**  $\Delta\nabla$  to place the pointer next to "MODE SET", then press **OK** or **PUSH JOG**  $\triangleright$ .

### 3 SELECT MODE

Press **PUSH JOG**  $\Delta\nabla$  to place the pointer next to "AUTO SP→LP TIMER", then press **OK** or **PUSH JOG**  $\triangleright$  to select "ON".

MODE SET	
AUTO TIMER	OFF
O. S. D.	ON
B. E. S. T.	ON
<input checked="" type="checkbox"/> AUTO SP→LP TIMER	ON
COLOUR SYSTEM PAL/NTSC	

[ $\Delta\nabla$ ] → [OK]  
[MENU] : EXIT

### 4 RETURN TO NORMAL SCREEN

Press **MENU**.

## NOTES:

- If you have programmed the recorder to timer-record 2 or more programmes, the second programme and those thereafter may not fit on the tape if you set "AUTO SP→LP TIMER" to "ON". In this case, make sure the mode is not engaged, then set the tape speed manually during timer programming.
- In order to ensure that the recording fits on the tape, this feature may leave a slight non-recorded section at the end of the tape.
- There may be some noise and sound disturbance at the point on the tape where the recorder switches from SP to LP mode.
- The Auto SP→LP Timer feature is not available during ITR (Instant Timer Recording), and the feature will not work properly with any tapes longer than E-180 or with some tapes of shorter lengths.
- If you perform timer recording with both VPS and the Auto SP→LP Timer activated, and the programme goes beyond its originally scheduled length, there may be times when the programme cannot be recorded in its entirety.

## Auto Timer

When the Auto Timer is set to ON, the timer is automatically engaged when the recorder power is turned off and automatically disengaged when the recorder is powered back on.

### 1 ACCESS MAIN MENU SCREEN

Press **MENU**.

### 2 ACCESS MODE SET SCREEN

Press **PUSH JOG**  $\Delta\nabla$  to place the pointer next to "MODE SET", then press **OK** or **PUSH JOG**  $\triangleright$ .

MAIN MENU	
<input checked="" type="checkbox"/> MODE SET	
AUTO CH SET	
MANUAL CH SET	
INITIAL SET	

[ $\Delta\nabla$ ] → [OK]  
[MENU] : EXIT

### 3 SELECT MODE

Press **OK** or **PUSH JOG**  $\triangleright$  to select either "ON" or "OFF".

- "AUTO SP→LP TIMER" appears only with the HR-J459EE.

MODE SET	
<input checked="" type="checkbox"/> AUTO TIMER	ON
O. S. D.	ON
B. E. S. T.	ON
AUTO SP→LP TIMER	OFF
COLOUR SYSTEM PAL/NTSC	

[ $\Delta\nabla$ ] → [OK]  
[MENU] : EXIT

### 4 RETURN TO NORMAL SCREEN

Press **MENU**.

## NOTE:

For safety, when Auto timer is set to "OFF", all other recorder functions are disabled while the Timer mode is engaged. To disengage the timer, press **TIMER**.

# Automatic Satellite Programme Recording

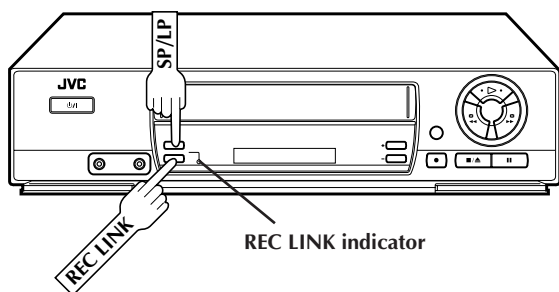

## ATTENTION

- Be sure to not turn on the satellite tuner before the programme is executed; otherwise, the recorder will start recording when the satellite tuner's power is turned on.
- If you have connected another appliance other than a satellite tuner to the AUDIO IN/VIDEO IN connectors, be sure to not engage the Auto Satellite Prog Rec mode; otherwise, the recorder will start recording when the connected appliance's power is turned on.
- Auto Satellite Prog recording and timer-recording cannot be done at the same time.

This facility allows you to record automatically a satellite programme which is timer-programmed on your external satellite tuner. Connect a satellite tuner to the recorder's AUDIO IN/VIDEO IN connectors and programme the timer on the satellite tuner; the recorder starts recording when the signals input from the satellite tuner to the AUDIO IN/VIDEO IN connectors, and when there is no input signals the recorder stops recording and the power shuts off.

### Before performing the following steps:

- Programme the timer on the satellite tuner.
- Insert a cassette with the safety tab in place.

## 1 SET TAPE SPEED (HR-J459EE ONLY)



Press **SP/LP** (  ) to set the tape speed.

## 2 ENGAGE AUTO SATELLITE PROG REC MODE

Press and hold **REC LINK** for about 2 seconds. The REC LINK indicator lights up and the recorder turns off automatically.

- To disengage the Auto Satellite Prog Rec mode, press **REC LINK**. The REC LINK indicator goes off.
- If the recorder's power is off, it is not possible to engage the Auto Satellite Prog Rec mode.

## NOTES:

- For timer programming of the satellite tuner, refer to the instruction manual of the satellite tuner.
- Auto Satellite Prog recording is not possible if your satellite tuner does not have a timer.
- The REC LINK indicator blinks while Auto Satellite Prog recording is in progress.
- Pressing the recorder's  button while Auto Satellite Prog recording is in progress turns off the recorder's power and disengages the Auto Satellite Prog Rec mode.
- If there are more than one satellite programme you wish to record with Auto Satellite Prog Recording, it is not possible to set the different tape speed per each; the tape speed selected in step 1 will be applicable to all the programmes for Auto Satellite Prog recording (HR-J459EE only).
- The B.E.S.T. system (  pg. 18 ) does not work while Auto Satellite Prog recording is in progress.
- Depending on the type of satellite tuner, the recorder may not record a slight portion of the beginning of the programme or may record slightly longer than the actual length of the programme.
- If you engage the Auto Satellite Prog Recording mode when the satellite tuner's power is on, the recorder will not start Auto Satellite Prog recording even though the REC LINK indicator blinks. When the satellite tuner shuts off once and is turned back on again, the recorder starts recording.
- When the Auto Satellite Prog Rec mode is engaged or the recorder's power is turned off after Auto Satellite Prog recording is finished, the recorder will not enter the Timer mode even though "AUTO TIMER" is set to "ON".
- After Auto Satellite Programme recording, the number of recorded programmes will not be displayed on the front display panel for the Instant ReView function (  pg. 15 ).
- You can also record a programme from your cable system in the same way if the system has a timer.

## TV Multi-brand Remote Control

Your remote control can operate the basic functions of your TV set. In addition to JVC TVs, other manufacturer's TVs can also be controlled.

Before you start . . .

- Turn on the TV using its remote control.

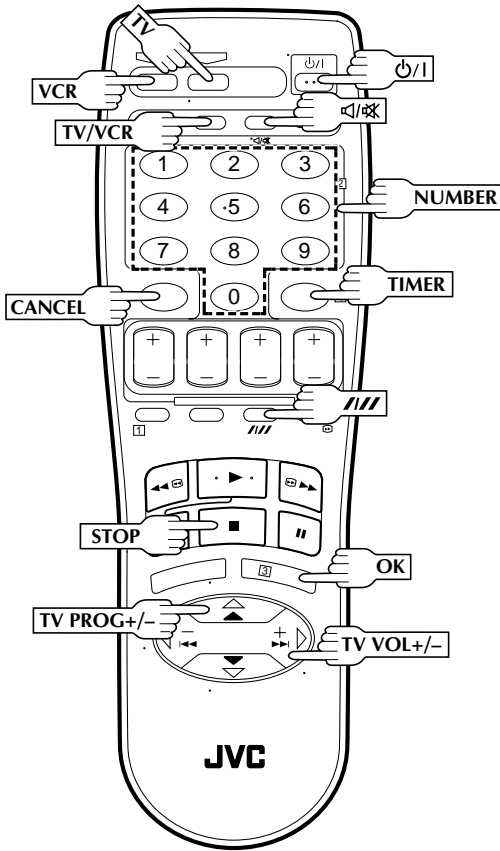

### 1 SET TV BRAND CODE

Refer to the chart below. While holding down **TV** on the recorder's remote control, enter your TV's brand code using the **NUMBER** keys, then press **STOP**. Check if the TV's power goes off as it should. If it does, try other operations (→ step 2)

- Once you have set the remote control to operate the TV, you don't have to repeat this step until you replace your remote control's batteries.
- SAMSUNG has two codes. If the TV does not function with one code, try entering another.

### 2 OPERATE TV

First, press **TV** to set the remote control to TV mode, then press the corresponding button: **POWER**, **TV PROG +/-**, **TV/VCR**, **TV VOL +/-** (Volume), **MUTE**, **NUMBER** keys.

- For some brands of TV, you must press **OK** after having pressed the **NUMBER** keys.

### IMPORTANT

*Although the provided remote control unit is compatible with JVC televisions, as well as many other models, it may not work with your TV, or in some instances, may have limited function capability.*

#### ATTENTION

The remote control can operate not only the video recorder but also some of your TV's functions.

- To operate your video recorder, first press the **VCR** button to set the remote control to the Video mode.
- To operate your TV, first press the **TV** button to set the remote control to the TV mode.

#### Control Your TV Using Additional Buttons

Use the **NUMBER** keys, and the **///** button, **CANCEL** button or **TIMER** button to select the TV's channel.

- With televisions under Code 01, 02, 03, 05, 07, 15 or 22, the **///** button corresponds to the 1-digit/2-digit entry switching button (often labelled - / -) of your TV's remote control.
- With televisions under Code 01, 08, 18 or 19, the **CANCEL** button corresponds to the 10 + button, and the **TIMER** button corresponds to the 20 + button of your TV's remote control.

#### NOTE:

*The way these buttons are used is determined by your TV. Use these buttons as instructed for your TV's remote control.*

TV BRAND NAME	CODE
JVC	01, 16
PANASONIC	02
SONY	03
SHARP	04
TOSHIBA	05
MITSUBISHI	06
HITACHI	07
SANYO	08
FUNAI	09
AIWA	10
DAEWOO	11
SAMSUNG	12, 16
LG/GOLDSTAR	13
THOMSON	14
FERGUSON	15
PHILIPS	16
GRUNDIG	17
ITT	18
MIVER	19
FINLUX	20
NOKIA	21
NEC	22

# Edit To Another Video Recorder

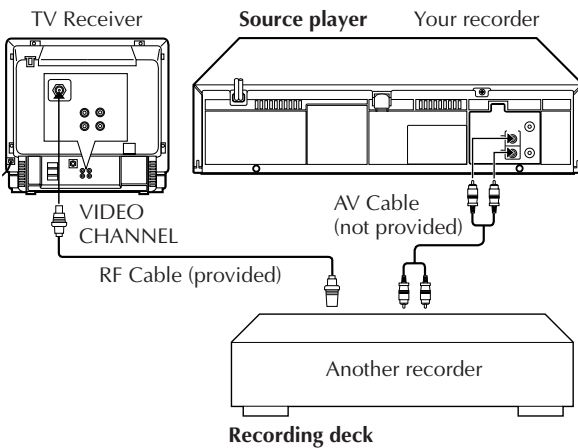
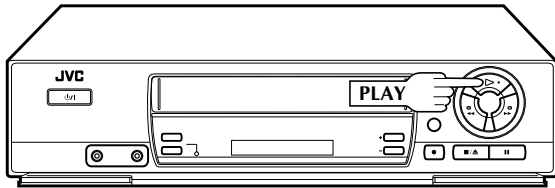

You can use your video recorder as the source player and another video recorder as the recording deck.

## 1 MAKE CONNECTIONS

Connect the player's AUDIO/VIDEO OUT connectors to the recorder's AUDIO/VIDEO IN connectors.

## 2 SET RECORDING DECK'S INPUT MODE

Set the recording deck's external input mode.

## 3 START SOURCE PLAYER

Press **PLAY** on the source player.

## 4 START RECORDING DECK

Engage its Record mode.

### NOTES:

- All necessary cables can be obtained from your dealer.
- If you do not want to record the superimposed indication on the edited tape, be sure to set "O.S.D." to "OFF" before you start editing (☞ pg. 10).

## Remote A/B Code Switching

The remote control is capable of controlling two JVC video recorders independently; one set to respond to the remote control's A code control signals and another set to respond to B code control signals. The remote control is preset to send A code signals because your video recorder is initially set to respond to A code signals. You can easily modify your video recorder to respond to B code signals.

- 1 Unplug the mains power cord from the mains outlet.
- 2 While holding down **VCR** on the remote control, press the **NUMBER** key "2" and then press **STOP**.
- 3 Plug the mains power cord back into the mains outlet.
- 4 Press **⏻/I** on the remote control. The recorder will now only respond to B code signals.

### NOTE:

To set the recorder back to respond to A code signals, repeat the same procedure as shown above except pressing **NUMBER** key "1" instead of "2" in step 2.

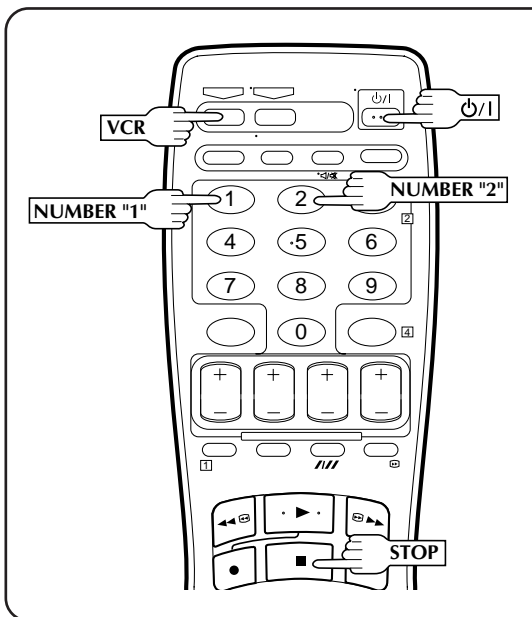

# Edit From A Camcorder Or Another Video Recorder

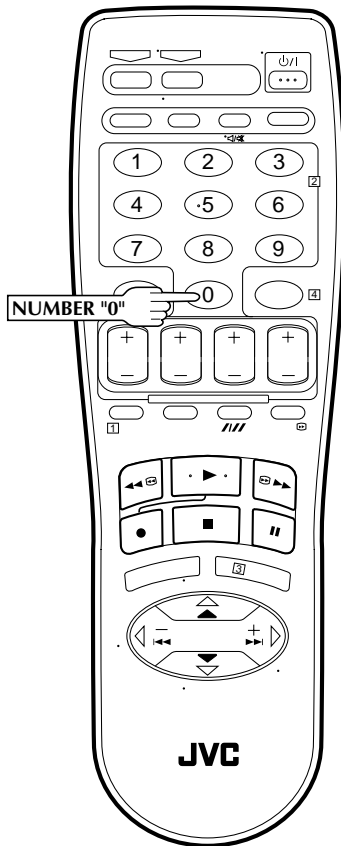

You can use a camcorder or another video recorder as the source player and your video recorder as the recording deck.

1

## MAKE CONNECTIONS

Connect the AUDIO/VIDEO OUT connectors on the camcorder or another video recorder to the front panel AUDIO/VIDEO input connectors on the recording deck.

2

## SET RECORDER'S INPUT MODE

Press **NUMBER** key "0" so that "F-1" appears on the display panel.

3

## START SOURCE PLAYER

Engage its Play mode.

4

## START RECORDING DECK

Engage its Record mode.

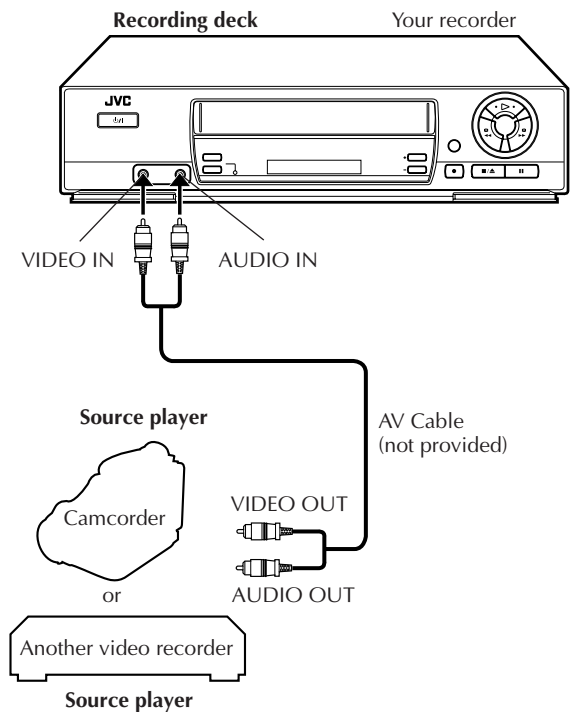

Turn on the TV and select the VIDEO channel (or AV mode).

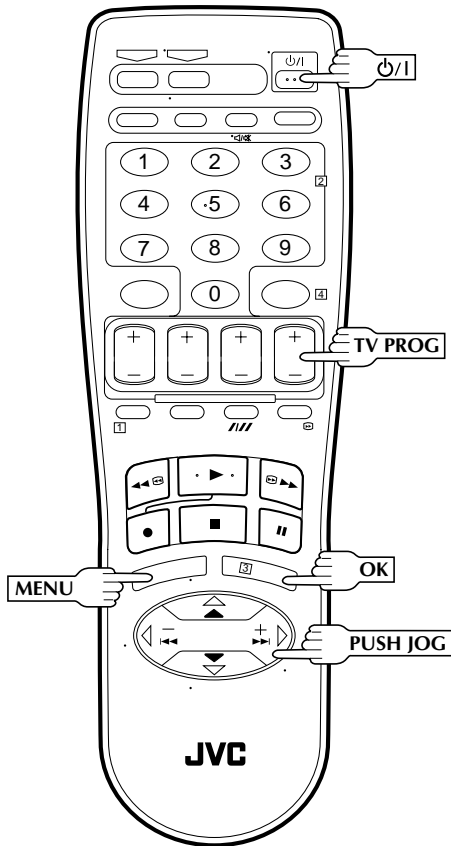

## IMPORTANT

Perform the following steps only if —

- Auto Channel Set has not been set correctly by Auto Set Up function (pg. 6).
- you have moved to a different area or if a new station starts broadcasting in your area.

Your recorder needs to memorise all necessary stations in channel positions in order to record TV programmes. Auto Channel Set automatically assigns all receivable stations in your area to call them up by using the **TV PROG** buttons without going through any vacant channel.

## Auto Channel Set

### TURN ON THE RECORDER

Press **Power/Standby**.

### ACCESS MAIN MENU SCREEN

Press **MENU**.

### PERFORM AUTO CHANNEL SET

Press **PUSH JOG**  $\Delta \nabla$  to place the pointer next to "AUTO CH SET", then press **OK** or **PUSH JOG**  $\triangleright$ .

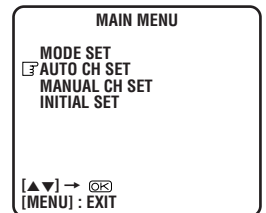

- The Auto Set screen appears, and remains on screen while the recorder searches for receivable stations. As Auto Channel Set progresses, the "■" mark on the screen moves from left to right. Wait until the screen as shown in step 4 appears.

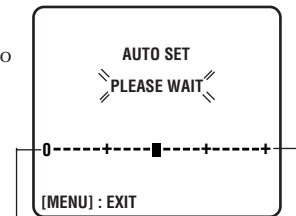

Beginning

End



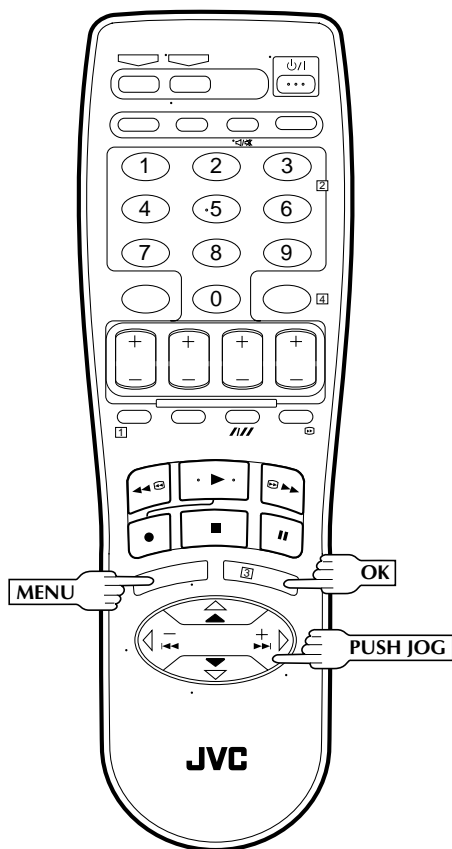

## VIEW CHANNEL LIST SCREEN

4

After "SCAN COMPLETED" is displayed on the screen for about 5 seconds, the Channel List screen looking like the one to the right appears. The stations your recorder located appear on the Channel List screen — channel positions (PR) and channels (CH).

PR	CH	ID	PR	CH	ID
01	25	----	07	C33	----
02	C08	---->	08	C26	----
03	10	----	09	55	----
04	C65	----	10	C24	----
05	C31	----	11	C23	----
06	C32	----	12	C25	----

[▲▼] : EDIT  
 → [OK] : EDIT  
 → [X] : DELETE  
 [MENU] : EXIT

C: Cable

The blueback screen and the program currently being broadcast by the blinking station appear alternately for 8 seconds each.

To view the next page, use the **PUSH JOG**  $\Delta \nabla$  button on the remote control.

## RETURN TO NORMAL SCREEN

5

Press **MENU**.

- Using the Channel List screen, you can skip or add channel positions, enter station names and perform other operations. Refer to pages 34 – 37 for the procedures.

### NOTES:

- Fine tuning is performed automatically during Auto Channel Set. If you want to perform it manually, refer to page 35.*
- If you perform Auto Channel Set when the aerial cable is not connected properly, "SCAN COMPLETED -NO SIGNAL-" appears on the screen in step 4. When this happens, make sure of the aerial connection and press **OK**; Auto Channel Set will take place again.*

### IMPORTANT

- If no sound accompanies the picture on some channels that have been stored by Auto Channel Set, the TV system setting for those channels may be incorrect. Select the appropriate TV system for those channels.  $\mathcal{E}$  "TV System Selection – When you see the picture but hear no audio" on page 37.
- Since your video recorder memorizes all detected stations even if the reception condition is poor, some of those stored stations may produce a noisy picture. To delete those stations,  $\mathcal{E}$  "Delete A Channel" on page 35.

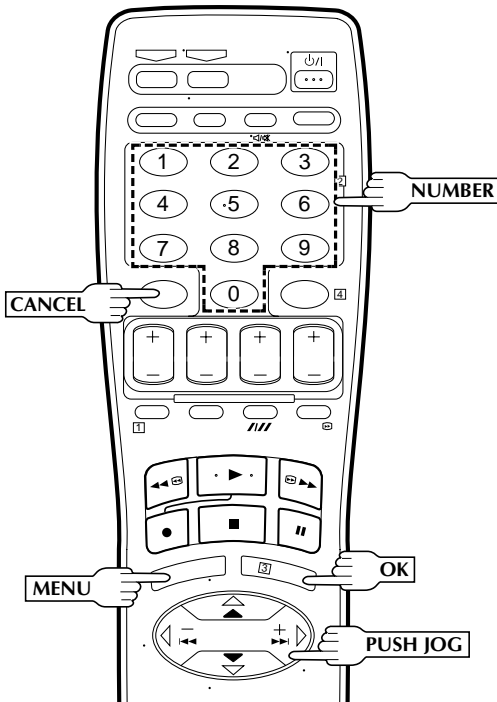

## Storing Channels Manually

Store channels that were not stored during Auto Set Up (☞ pg. 6) or Auto Channel Set (☞ pg. 32).

- ### 1 ACCESS MAIN MENU

Press **MENU**.
- ### 2 ACCESS CHANNEL LIST SCREEN

Press **PUSH JOG**  $\Delta \nabla$  to place the pointer next to "MANUAL CH SET", then press **OK** or **PUSH JOG**  $\triangleright$ . The Channel List screen appears.
- ### 3 SELECT POSITION

Press **PUSH JOG**  $\Delta \nabla$  until an open position in which you want to store a channel begins blinking, then press **OK**. The Manual Channel Set screen appears.

(Ex.) To store in position 12.

PR	CH	ID	PR	CH	ID
01	25	----	07	C33	----
02	CDB	----	08	C26	----
03	10	----	09	55	----
04	C65	----	10	C24	----
05	C31	----	11	C23	----
06	C32	----	12	----	----

[ $\Delta \nabla$ ] : SELECT  
 [←▶] : CURSOR ←→  
 [OK] : OK  
 [MENU] : EXIT

[←▶] : EDIT  
 [CANCEL] : DELETE  
 [MENU] : EXIT

The blueback screen and the programme currently being broadcast by the selected channel appear alternately for 8 seconds each.

## 4 SELECT BAND

Press **PUSH JOG**  $\Delta \nabla$  to change the band between CH (regular) and CC (cable), then press **PUSH JOG**  $\triangleright$ .

PR	CH	ID	FINE	SYSTEM
12	CH01	----	+/-	D/K

[ $\Delta \nabla$ ] : SELECT  
 [←▶] : CURSOR ←→  
 [OK] : OK  
 [MENU] : EXIT

The blueback screen and the programme currently being broadcast by the selected channel appear alternately for 8 seconds each.

## 5 INPUT CHANNEL

Press the **NUMBER** keys to input the channel number you want to store.

- Input "0" before any single number entries.
- To input the registered station name (ID – ☞ pg. 38), press **PUSH JOG**  $\triangleright$  until "----" (ID setting) begins blinking, then press **PUSH JOG**  $\Delta \nabla$ .
- For fine tuning adjustment, press **PUSH JOG**  $\triangleright$  until "+/-" begins blinking, then press **PUSH JOG**  $\Delta \nabla$ . While tuning, "+" or "-" appears.
- To select the appropriate TV system, press **PUSH JOG**  $\triangleright$  until TV system setting (B/G or D/K) blinks, then press **PUSH JOG**  $\Delta \nabla$ . Refer to the table below.

## 6 ENTER NEW CHANNEL INFORMATION

Press **OK** and the Channel List screen appears.

- Repeat steps 3 through 6 as necessary.

## 7 CLOSE CHANNEL LIST SCREEN

Press **MENU**.

- To change positions, see "Change Station Channel Position" (☞ pg. 35).
- If you wish to set station names other than the ones registered in your recorder, ☞ "Set Stations (B)" on page 37.

Major Countries	TV System
Austria, Denmark, Finland, Holland, Italy, Norway, Spain, Switzerland, Sweden, Germany, Egypt	B/G
China, Mongolia, Rumania, Bulgaria, Czech Rep., Slovakia, Hungary, Poland, Russia	D/K

## Delete A Channel

Perform steps 1 and 2 of "Storing Channels Manually" on page 34 to access the Channel List screen before continuing.

- 1** **SELECT ITEM**  
Press **PUSH JOG**  $\Delta\nabla$  until the item you want to delete begins blinking.
- 2** **DELETE CHANNEL**  
Press **CANCEL**.
  - The item directly beneath the cancelled one moves up one line.
  - Repeat steps 1 and 2 as necessary.
- 3** **CLOSE CHANNEL LIST SCREEN**  
Press **MENU**.

## Change Station Channel Position

Perform steps 1 and 2 of "Storing Channels Manually" on page 34 to access the Channel List screen before continuing.

- 1** **SELECT ITEM**  
Press **PUSH JOG**  $\Delta\nabla$  until the item you want to move begins blinking. Then press **OK** and the station name (ID) and its channel (CH) number begin blinking.
  - 2** **SELECT NEW POSITION**  
Press **PUSH JOG**  $\Delta\nabla$  to move the station to the new channel position, then press **OK**.  
Example: If you moved the station in position 4 to position 2, the stations originally in positions 2 and 3 each move down one space.
- | PR | CH  | ID   | PR | CH  | ID   | PR | CH  | ID   | PR | CH  | ID   |
|----|-----|------|----|-----|------|----|-----|------|----|-----|------|
| 01 | 25  | ---- | 07 | C33 | ---- | 01 | 25  | ---- | 07 | C33 | ---- |
| 02 | C08 | ---- | 08 | C26 | ---- | 02 | C65 | ---- | 08 | C26 | ---- |
| 03 | 10  | ---- | 09 | 55  | ---- | 03 | C08 | ---- | 09 | 55  | ---- |
| 04 | C65 | ---- | 10 | C24 | ---- | 04 | 10  | ---- | 10 | C24 | ---- |
| 05 | C31 | ---- | 11 | C23 | ---- | 05 | C31 | ---- | 11 | C23 | ---- |
| 06 | C32 | ---- | 12 | C25 | ---- | 06 | C32 | ---- | 12 | C25 | ---- |
- [ $\Delta\nabla$ ]: MOVE  
[OK]: MANUAL CH SET  
[MENU]: EXIT

→

[ $\Delta\nabla$ ]: MOVE → [OK]  
[MENU]: EXIT
- Repeat steps 1 and 2 as necessary.
- 3** **CLOSE CHANNEL LIST SCREEN**  
Press **MENU**.

## Fine-Tuning Channels Already Stored

Perform steps 1 and 2 of "Storing Channels Manually" on page 34 to access the Channel List screen before continuing.

- 1** **SELECT CHANNEL TO FINE-TUNE**  
Press **PUSH JOG**  $\Delta\nabla$  until the channel you want to tune begins blinking.
- 2** **ACCESS MANUAL CHANNEL SET SCREEN**  
Press **OK** twice. The Manual Channel Set screen appears.
- 3** **PERFORM TUNING**  
Press **PUSH JOG**  $\triangleright$  until "+/-" begins blinking, then press **PUSH JOG**  $\Delta\nabla$  until the picture is its clearest. Then press **OK**.
  - The Channel List screen appears.
  - Repeat steps 1 through 3 as necessary.
- 4** **CLOSE CHANNEL LIST SCREEN**  
Press **MENU**.

## Set Stations (A)

Set station names that are registered in your recorder.

Perform steps 1 and 2 of "Storing Channels Manually" on page 34 to access the Channel List screen before continuing.

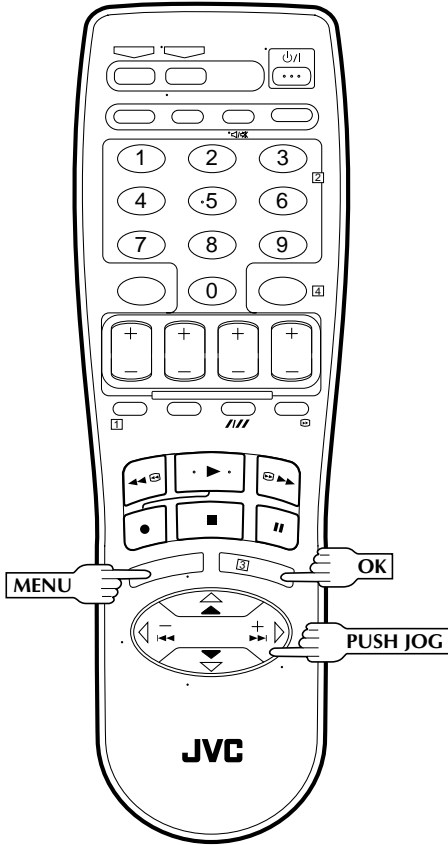

### 1 SELECT ITEM

Press **PUSH JOG**  $\Delta \nabla$  until the item you want begins blinking.

### 2 ACCESS MANUAL CHANNEL SET SCREEN

Press **OK** twice.

### 3 SELECT NEW STATION

Press **PUSH JOG**  $\triangleright$  until the station name (ID) begins blinking, then press **PUSH JOG**  $\Delta \nabla$  until the new station's name (ID) you want to store begins blinking.

Registered station names (pg. 38) appear as you press **PUSH JOG**  $\Delta \nabla$ .

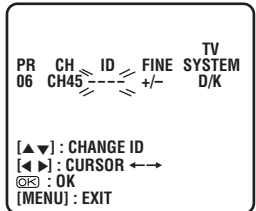

### 4 SWITCH STATIONS

Press **OK**.

- The Channel List screen appears.
- Repeat steps 1 through 4 as necessary.

### 5 CLOSE CHANNEL LIST SCREEN

Press **MENU**.

## Set Stations (B)

Set station names other than the ones registered in your recorder.

Perform steps 1 and 2 of "Storing Channels Manually" on page 34 to access the Channel List screen and then perform step 1 and 2 of "Set Stations (A)" on the left before continuing.

### SELECT STATION NAME CHARACTER

- 1** Press **PUSH JOG**  $\triangleright$  until the first letter of the station name begins blinking.

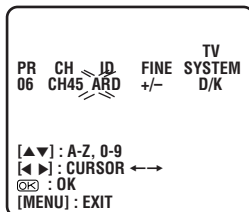

### ENTER NEW CHARACTER

- 2** Press **PUSH JOG**  $\Delta\nabla$  to cycle through the characters (A-Z, 0-9, -, \*, +, — (space) ) and stop when the desired character is indicated, then press **PUSH JOG**  $\triangleright$  to enter. Enter the remaining characters the same way (maximum of 4). After entering all characters, press **OK**.

- The Channel List screen appears.
- If you make a mistake, press **PUSH JOG**  $\triangleleft$  until the incorrect character begins blinking. Then enter the correct character by pressing **PUSH JOG**  $\Delta\nabla$ .

### CLOSE CHANNEL LIST SCREEN

- 3** Press **MENU**.

## TV System Selection - When you see the picture but hear no audio

Perform steps 1 and 2 of "Storing Channels Manually" on page 34 to access the Channel List screen before continuing.

### SELECT CHANNEL POSITION

- 1** Press **PUSH JOG**  $\Delta\nabla$  until the channel position you want to change its TV system begins blinking, then press **OK**. The Manual Channel Set screen appears.

### SELECT TV SYSTEM

- 2** Press **PUSH JOG**  $\triangleright$  until TV system setting (D/K or B/G) begins blinking and then press **PUSH JOG**  $\Delta\nabla$  to select the appropriate TV system. Refer to the table on page 34 also.

### RETURN TO CHANNEL LIST SCREEN

- 3** Press **OK**.
- The Channel List screen appears.
  - Repeat steps 1 through 3 as necessary.

### CLOSE CHANNEL LIST SCREEN

- 4** Press **MENU**.

## TV Station And ID List

ID*	STATION NAME
1000	TV1000
3SAT	3SAT
ADLT	ADULT
ANT3	ANTENA3
ARD	ARD
ARTE	ARTE
BBC	BBC GROUP
BBC1	BBC1
BBC2	BBC2
BR3	BAYERN3
C+	CANAL PLUS
C1	PORTUGUSES
CAN5	CANALE5
CH4	CHANNEL4
CH5	CHANNEL5
CHLD	CHILD
CINE	CINEMA
CLUB	TELECLUB
CMT	CMT
CNN	CNN
CSUR	ANDALUCIA
DISC	DISCOVERY
DR	DR TV
DRS	DRS
DSF	DSF
ETB1	ETB1
ETB2	ETB2
EURO	EURONEWS
EUSP	EUROSPORTS
FEMM	FEMMAN
FILM	FILM
FNET	FILMNET
FR2	France2
FR3	France3
GALA	GALAVISION
HR3	HESSEN3
INFO	INFO-KANAL
ITA1	ITALIA1
ITA7	ITALIA7
ITV	ITV
JSTV	JSTV
KA2	KA2
KAB1	KABEL1
KAN2	KANAL2
LOCA	LOCAL
M6	M6
MBC	MBR
MCM	MCM
MDR	MDR
MOVE	MOVIE
MTV	MTV
MTV3	MTV3
N3	NORD3
N-TV	N-TV
NBC	NBC SUPER
NDR3	NDR3
NED1	NED1
NED2	NED2
NED3	NED3
NEWS	
NICK	NICKELODEON
NRK	NRK
NRK2	NRK2
ODE	ODEON
ORF1	ORF1

ID*	STATION NAME
ORF2	ORF2
ORF3	ORF3
OWL3	OWL3
PREM	PREMIERE
PRO7	PRO7
RAI1	RAI1
RAI2	RAI2
RAI3	RAI3
RET4	RETE4
21	TELE21
RTBF	RTBF1 or 2
RTL	RTL
RTL2	RTL2
RTL4	RTL4
RTL5	RTL5
RTP	RTP
S4	SCHWEIZ4
SAT1	SAT1
SBS	SBS
SHOW	SHOW
SIC	SOCIEDADE
SKY	SKY CHANNEL
SKYN	SKY NEWS
SPRT	SPORT
SRTL	SUPER RTL
STAR	STAR-TV
SVT1	SVT1
SVT2	SVT2
SW3	SUEDWEST3
TCC	TCC
TELE	TELE
TEL5	TELE5
TF1	TF1
TM3	TM3
TMC	TELEMONTECARLO
TNT	TNT INT
TRT	TRT INT
TSI	TSI
TSR	TSR
TV1	BRTN TV1
TV2	BRTN TV2
TV3	TV3
TV4	TV4
TV5	TV5
TV6	TV6
TVE1	TVE1
TVE2	TVE2
TVG	TV GALICIA
TVI	TV INDEPENDENT
TVN	TV NORGE
VCR	VIDEO
VERO	VERONICA
VH-1	VH-1
VIVA	VIVA
VIV2	VIVA2
VMTV	VIDEO MUSIC
VOX	VOX
VT4	VT4
VTM	VTM
WDR1	West1
WDR3	West3
YLE1	YLE1
YLE2	YLE2
ZDF	ZDF
ZTV	ZTV

\* The "ID" abbreviation is what is shown on-screen in lieu of the station name. The "ID" abbreviation is listed in the Channel List screen and is displayed on the TV screen when the recorder is tuned to a different station.

**PLAYBACK**

- Q. What happens if the end of the tape is reached during playback or search?**  
A. The tape is automatically rewound to the beginning.  
.....
- Q. Can the video recorder indefinitely remain in the still mode?**  
A. No. It stops automatically after 5 minutes to protect the heads.  
.....
- Q. During search, slow, still and frame-by-frame playback, I can't hear any audio. What's the problem?**  
A. This is normal.  
.....
- Q. When returning from multi-speed search to normal playback, the picture is disturbed. Should I be concerned about this?**  
A. No, it is normal.  
.....
- Q. Noise bars appear during multi-speed search. What's the problem?**  
A. This is normal.  
.....
- Q. Other than preventing further recording, what effect does removing the Record Safety tab have?**  
A. It disables marking of index codes.  
.....
- Q. Sometimes, during Index Search, the video recorder can't find the programme I want to see. Why not?**  
A. There may be index codes too close together.  
.....

**RECORDING**

- Q. When I pause and then resume a recording, the end of the recording before the pause is overlapped by the beginning of the continuation of recording. Why does this happen?**  
A. This is normal. It reduces distortion at the pause and resume points.  
.....
- Q. Can the video recorder indefinitely remain in the Record-Pause mode?**  
A. No. The video recorder goes to its Stop mode automatically after 5 minutes to protect the heads.  
.....
- Q. What happens if the tape runs out during recording?**  
A. The video recorder automatically rewinds it to the beginning.  
.....

**TIMER RECORDING**

- Q. "⦿" and "⊖" remain lit on the display panel. Is there a problem?**  
A. No. This is a normal condition for a timer recording in progress.  
.....
- Q. Can I program the timer while I'm watching a tape or a TV broadcast?**  
A. You won't see the picture as it is replaced by the on-screen menu, but the audio from the program or tape you're viewing can be heard.  
.....
- Q. Is it possible to timer-record a TV programme broadcast in 2000?**  
A. Yes, it is possible.  
.....

**ATTENTION:**

This recorder contains microcomputers. External electronic noise or interference could cause malfunctioning. In such cases, switch the recorder off and unplug the mains power cord. Then plug it in again and turn the recorder on. Take out the cassette. After checking the cassette, operate the unit as usual.

Before requesting service for a problem, use this chart and see if you can repair the trouble yourself. Small problems are often easily corrected, and this can save you the trouble of sending your video recorder off for repair.

<b>POWER</b>		
<b>SYMPTOM</b>	<b>POSSIBLE CAUSE</b>	<b>CORRECTIVE ACTION</b>
1. No power is applied to the recorder.	<ul style="list-style-type: none"> <li>The mains power cord is disconnected.</li> </ul>	Connect the mains power cord.
2. The clock is functioning properly, but the recorder cannot be powered.	<ul style="list-style-type: none"> <li>"⊖" is displayed on the display panel with Auto Timer set to "OFF".</li> </ul>	Press the <b>TIMER</b> button to turn the "⊖" indicator off.
3. The remote control won't function.	<ul style="list-style-type: none"> <li>The batteries are discharged.</li> <li>The remote control is set to the wrong operating mode.</li> </ul>	Replace the dead batteries with new ones. Press the appropriate button ( <b>TV</b> or <b>VCR</b> ) depending on the unit you want to operate. (☞ pg. 29)
<b>TAPE TRANSPORT</b>		
<b>SYMPTOM</b>	<b>POSSIBLE CAUSE</b>	<b>CORRECTIVE ACTION</b>
1. The tape does not run during recording.	<ul style="list-style-type: none"> <li>"⏏" is displayed on the display panel.</li> </ul>	Press <b>PLAY</b> to turn the "⏏" indicator off.
2. The tape will not rewind or fast-forward.	<ul style="list-style-type: none"> <li>The tape is already fully rewound or fast-forwarded.</li> </ul>	Check the cassette.
<b>PLAYBACK</b>		
<b>SYMPTOM</b>	<b>POSSIBLE CAUSE</b>	<b>CORRECTIVE ACTION</b>
1. The playback picture does not appear while the tape is running.	<ul style="list-style-type: none"> <li>If you're using the RF OUT connection . . . . . the TV receiver's channel selector is not set to the VIDEO channel. . . . the recorder's VIDEO channel has not been correctly set.</li> <li>If you're using the AV connection, the TV receiver is not set to the AV mode.</li> </ul>	If you are using the RF OUT connection . . . . . set the TV receiver to the VIDEO channel. (☞ pg. 4) . . . Perform "Video Channel Set" (☞ pg. 4) If you are using the AV connection, set the TV to its AV mode.
2. Noise appears during visual search.	<ul style="list-style-type: none"> <li>This is normal.</li> </ul>	
3. Noise appears during normal playback.	<ul style="list-style-type: none"> <li>The automatic tracking mode is engaged.</li> </ul>	Try manual tracking. (☞ pg. 14)
4. Noise appears during slow-motion playback.	<ul style="list-style-type: none"> <li>The automatic tracking mode is engaged.</li> </ul>	Try manual tracking. (☞ pg. 14)
5. Noise appears during still playback.		Press <b>TV PROG +</b> or <b>-</b> a few times to remove the noise bars from the screen.
6. The playback picture is blurred or interrupted while TV broadcasts are clear.	<ul style="list-style-type: none"> <li>The video heads may be dirty.</li> </ul>	Consult your JVC dealer.
7. No sound accompanies the playback picture.	<ul style="list-style-type: none"> <li>The TV system you have selected at the TV System Select screen is incorrect.</li> </ul>	Set it to the correct position for the TV broadcast system used in your area. (☞ pg. 37.)



## RECORDING

SYMPTOM	POSSIBLE CAUSE	CORRECTIVE ACTION
1. Recording cannot be started.	<ul style="list-style-type: none"> <li>There is no cassette loaded, or the cassette loaded has had its Record Safety tab removed.</li> </ul>	Insert a cassette, or using adhesive tape, reseal the slot where the tab was removed.
2. TV broadcasts cannot be recorded.	<ul style="list-style-type: none"> <li>"F-1" has been selected as the input mode.</li> </ul>	Set to the desired channel.
3. Tape-to-tape editing is not possible.	<ul style="list-style-type: none"> <li>The source (another video recorder, camcorder) has not been properly connected.</li> <li>All necessary power switches have not been turned on.</li> <li>The input mode is not correct.</li> </ul>	<p>Confirm that the source is properly connected.</p> <p>Confirm that all units' power switches are turned on. Set the input mode to "F-1".</p>
4. Camcorder recording is not possible.	<ul style="list-style-type: none"> <li>The camcorder has not been properly connected.</li> <li>The input mode is not correct.</li> </ul>	<p>Confirm that the camcorder is properly connected.</p> <p>Set the input mode to "F-1".</p>

## TIMER RECORDING

SYMPTOM	POSSIBLE CAUSE	CORRECTIVE ACTION
1. Timer recording won't work.	<ul style="list-style-type: none"> <li>The clock and/or the timer have been set incorrectly.</li> <li>The timer is not engaged.</li> </ul>	Re-perform the clock and/or timer settings. Press <b>TIMER</b> and confirm that "Ⓣ" is displayed on the display panel.
2. On-screen timer programming is not possible.	<ul style="list-style-type: none"> <li>Timer recording is in progress.</li> </ul>	Timer programming can't be performed while a timer recording is in progress. Wait until it finishes.
3. "Ⓣ" and "Ⓣ" on the display panel won't stop blinking.	<ul style="list-style-type: none"> <li>The timer is engaged but there's no cassette loaded.</li> </ul>	Load a cassette with the Record Safety tab intact, or cover the hole using adhesive tape.
4. The cassette is automatically ejected, and "Ⓣ" and "Ⓣ" on the display panel won't stop blinking.	<ul style="list-style-type: none"> <li>The loaded cassette has had its Record Safety tab removed.</li> </ul>	Remove the cassette and cover the hole with adhesive tape, or insert a cassette with the Record Safety tab intact.
5. "Ⓣ" blinks for 10 seconds and the Timer mode is disengaged.	<ul style="list-style-type: none"> <li><b>TIMER</b> has been pressed when there are no programs in memory, or the timer record information has been programmed incorrectly.</li> </ul>	Check the programmed data and re-program as necessary, then press <b>TIMER</b> again.
6. The cassette is automatically ejected, the power shuts off and "Ⓣ" and "Ⓣ" won't stop blinking.	<ul style="list-style-type: none"> <li>The end of the tape was reached during timer recording.</li> </ul>	The programme may not have been recorded in its entirety. Next time make sure you have enough time on the tape to record the entire programme.
7. SHOWVIEW does not timer-record properly.	<ul style="list-style-type: none"> <li>The recorder's channel positions have been set incorrectly.</li> </ul>	Refer to "Guide Program Number Set" and re-perform the procedure (pg. 20).

## OTHER PROBLEMS

SYMPTOM	POSSIBLE CAUSE	CORRECTIVE ACTION
1. Whistling or howling is heard from the TV during camcorder recording.	<ul style="list-style-type: none"> <li>● The camcorder's microphone is too close to the TV.</li> <li>● The TV's volume is too high.</li> </ul>	Position the camcorder so its microphone is away from the TV. Turn the TV's volume down.
2. When scanning channels, some of them are skipped over.	<ul style="list-style-type: none"> <li>● Those channels have been designated to be skipped.</li> </ul>	If you need the skipped channels, restore them (☞ pg. 34).
3. The channel cannot be changed.	<ul style="list-style-type: none"> <li>● Recording is in progress.</li> </ul>	Press <b>PAUSE</b> to pause the recording, change channels, then press <b>PLAY</b> to resume recording.
4. Channel settings that were made manually seem to have changed or disappeared.	<ul style="list-style-type: none"> <li>● After the manual settings were made, Auto Channel Set was performed.</li> </ul>	Perform manual setting again.
5. No channels are stored in the recorder's memory.	<ul style="list-style-type: none"> <li>● The TV aerial cable was not connected to the recorder when Auto Set Up was performed..</li> </ul>	Connect the TV aerial cable to the recorder properly and turn off the recorder power once, then turn the recorder power back on again. The recorder will try Auto Set Up again (☞ pg. 6).

FRONT VIEW

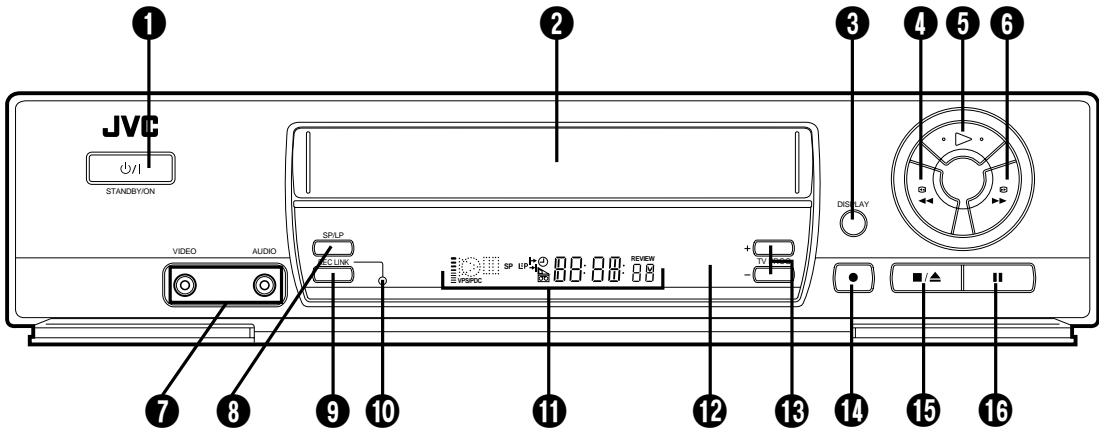

- ❶ STANDBY/ON  $\phi$ /I Button  $\hookrightarrow$  pg. 5
- ❷ Cassette Loading Slot
- ❸ DISPLAY Button  $\hookrightarrow$  pg. 17
- ❹ Rewind [REW] Button  $\hookrightarrow$  pg. 12, 13
- ❺ PLAY Button  $\hookrightarrow$  pg. 12
- ❻ Fast Forward Button  $\hookrightarrow$  pg. 12, 13
- ❼ VIDEO/AUDIO Input Connectors  $\hookrightarrow$  pg. 31
- ❽ SP/LP Button  $\hookrightarrow$  pg. 16 (HR-J459EE)  
COUNTER RESET Button  $\hookrightarrow$  pg. 17 (HR-J259EE)
- ❾ REC LINK Button  $\hookrightarrow$  pg. 28
- ❿ REC LINK Indicator  $\hookrightarrow$  pg. 28
- ⓫ Display Panel  $\hookrightarrow$  pg. 44
- ⓬ Infrared Beam Receiving Window
- ⓭ TV PROG +/- Buttons  $\hookrightarrow$  pg. 16
- ⓮ RECORD Button  $\hookrightarrow$  pg. 16
- ⓯ STOP/EJECT Button  $\hookrightarrow$  pg. 12
- ⓰ PAUSE Button  $\hookrightarrow$  pg. 13

REAR VIEW

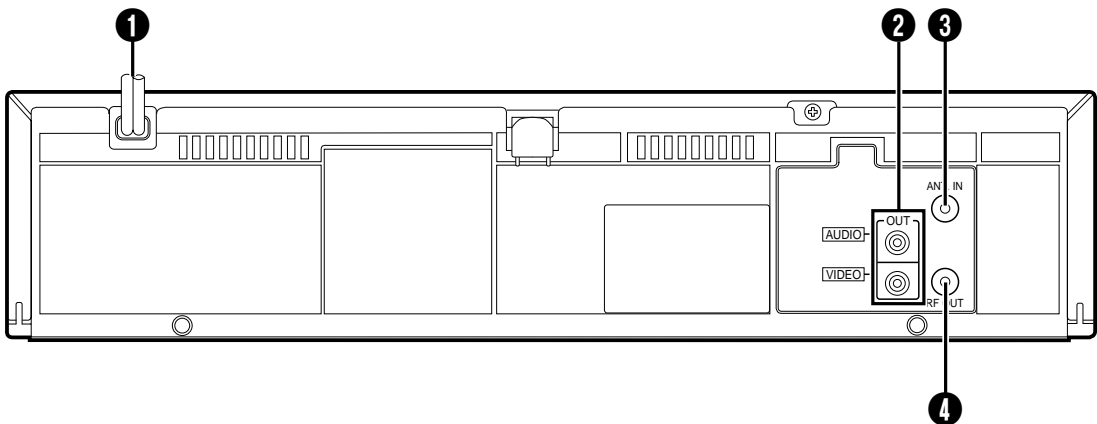

- ❶ Mains Power Cord  $\hookrightarrow$  pg. 3
- ❷ AUDIO/VIDEO OUT Connectors  $\hookrightarrow$  pg. 3, 30
- ❸ ANT. IN Connector  $\hookrightarrow$  pg. 3
- ❹ RF OUT Connector  $\hookrightarrow$  pg. 3

## DISPLAY PANEL

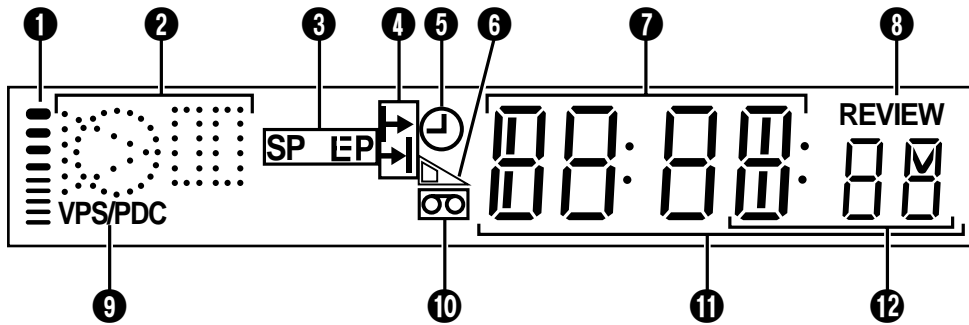

- ❶ B.E.S.T. Picture System Display [↗](#) pg. 19
- ❷ Symbolic Mode Indicators

PLAY: VARIABLE SHUTTLE SEARCH:		STILL:	
		SLOW:	
		RECORD PAUSE:	

- ❸ Tape Speed Indicators [↗](#) pg. 16
- ❹ Programme Time Indicators [↗](#) pg. 24
- ❺ "Timer" Indicator [↗](#) pg. 23
- ❻ Tape Remaining Time Indicator [↗](#) pg. 17
- ❼ Channel Display  
Clock Display
- ❽ Instant REVIEW Indicator [↗](#) pg. 15
- ❾ VPS Indicator [↗](#) pg. 23, 25  
\* PDC (Programme Delivery Control) recording is not possible with this recorder.
- ❿ "Cassette Loaded" Mark
- ⓫ Counter/Remain Display
- ⓬ Mode Display (F-1)

## REMOTE CONTROL

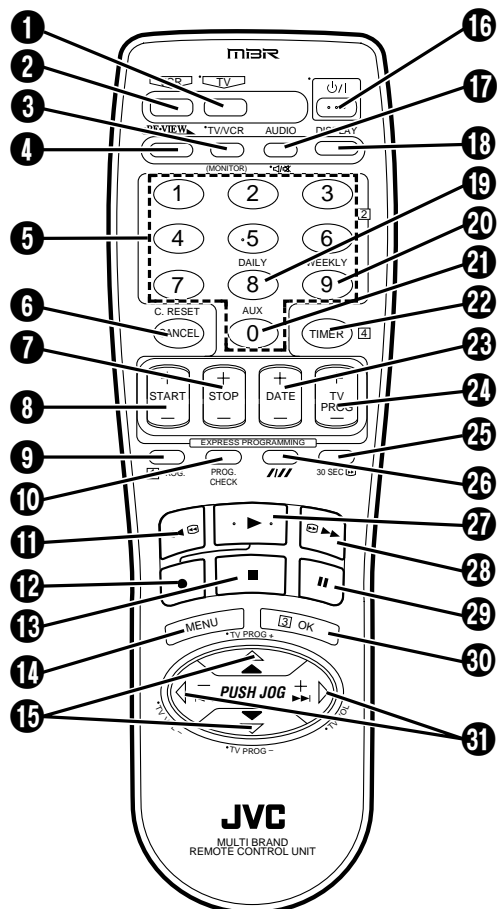

- 1 TV Button ☞ pg. 29
- 2 VCR Button ☞ pg. 29
- 3 TV/VCR Button ☞ pg. 29
- 4 REVIEW Button ☞ pg. 15
- 5 NUMBER Keys ☞ pg. 16
- 6 CANCEL Button ☞ pg. 22
- 7 STOP +/- Button ☞ pg. 23
- 8 START +/- Button ☞ pg. 24
- 9 PROG. Button ☞ pg. 22
- 10 PROG. CHECK Button ☞ pg. 26
- 11 Rewind [REW] Button ☞ pg. 12
- 12 Record Button ☞ pg. 16
- 13 Stop Button ☞ pg. 12
- 14 MENU Button ☞ pg. 7
- 15 PUSH JOG  $\Delta$ / $\nabla$  Button ☞ pg. 6
- 16 STANDBY/ON  $\psi$ / $\uparrow$  Button ☞ pg. 5
- 17  $\triangleleft$ / $\triangleright$  (TV Muting) Button ☞ pg. 29
- 18 DISPLAY Button ☞ pg. 17
- 19 DAILY Button ☞ pg. 23
- 20 WEEKLY Button ☞ pg. 23
- 21 AUX Button ☞ pg. 31
- 22 TIMER Button ☞ pg. 23
- 23 DATE +/- Button ☞ pg. 24
- 24 TV PROG +/- Button ☞ pg. 16, 25
- 25 30 SEC Button ☞ pg. 15
- 26 Tracking Button ☞ pg. 14
- 27 SP/LP Button ☞ pg. 16
- 27 Play Button ☞ pg. 12
- 28 Fast Forward [FF] Button ☞ pg. 12
- 29 Pause Button ☞ pg. 13
- 30 OK Button ☞ pg. 5
- 31 PUSH JOG  $\triangleleft$ / $\triangleright$  Button ☞ pg. 13, 15
- TV VOL +/- Button ☞ pg. 29

Buttons with a small dot on the left side of the name can also be used to operate your TV ☞ pg. 29.

### How To Use

The remote control can operate most of your video recorder's functions, as well as basic functions of TV sets of JVC and other brands. ☞ pg. 29.

- Point the remote control toward the sensor window.
- The maximum operating distance of the remote control is about 8 m.

### NOTES:

- When inserting the batteries, be sure to insert in the correct directions as indicated under the battery cover.
- If the remote control doesn't work properly, remove its batteries, wait a short time, replace the batteries and then try again.

### ATTENTION

The remote control can operate not only the video recorder but also some of your TV's functions.

- To operate your video recorder, first press the **VCR** button to set the remote control to the Video mode.
- To operate your TV, first press the **TV** button to set the remote control to the TV mode (☞ pg. 29).

**GENERAL**

Power requirement	
Rating	: AC 110 – 240 V~, 50/60 Hz
Operating	: AC 90 – 260 V~, 50/60 Hz
Power consumption	: 18W
Temperature	
Operating	: 5°C to 40°C
Storage	: -20°C to 60°C
Operating position	: Horizontal only
Dimensions (WxHxD)	: 400 x 94 x 277 mm
Weight	: 3.4 kg
Format	: VHS standard
Maximum recording time	
(SP)	: 240 min. with E-240 video cassette
(LP) [J459EE only]	: 480 min. with E-240 video cassette

**VIDEO/AUDIO**

Signal system	: PAL-type colour signal and CCIR monochrome signal, 625 lines 50 fields
	: NTSC colour and EIA monochrome signals, 525 lines/60 fields
Recording system	: DA-4 (Double Azimuth) head helical scan system [J459EE]
	: Rotary two-head helical scan system [J259EE]
Signal-to-noise ratio	: 45 dB
Horizontal resolution	: 250 lines
Frequency range	: 70 Hz to 10,000 Hz
Input/Output	: RCA connectors (IN x 1, OUT x 1)

**TUNER/TIMER**

TV channel storage capacity	: 99 positions (+AUX position)
Tuning system	: Frequency synthesized tuner
Channel coverage	: VHF 47 – 100/104 – 300/302 – 470MHz
	: UHF 470 – 862MHz
Aerial output	: UHF channels (Adjustable E28 – E60)
Memory backup time	: Approx. 18 hours
Backup time becomes shorter as the unit's internal parts become old. When this occurs, please consult your nearby JVC dealer.	

**ACCESSORIES**

Provided accessories	: RF cable, Infrared remote control unit, "R6/UM-3" battery x 2
----------------------	---

*Specifications shown are for SP mode unless otherwise specified.*

*Design and specifications subject to change without notice.*



